



The power behind competitiveness

Delta UPS Solutions

Uninterruptible Power Supply

www.deltapowersolutions.com





Contents

Delta Group	1
About MCIS	3
Delta UPS	4
Product	6
• Agilon & Amplon	
• Ultron & Modulon	
• Product Application Matrix	
• UPS Management	
Technical Specifications	36
UPS Q&A	54

Delta Group

Delta Group is the world's leading provider of power management and thermal management solutions, as well as a major source for components, visual displays, industrial automation, networking products, and renewable energy solutions. Delta Group is focused on three main businesses: power electronics, energy management, and smart green life. Delta Group has sales offices worldwide and manufacturing plants in Taiwan, China, Thailand, Japan, Mexico, India, Brazil and Europe.

As a global leader in power electronics, Delta's mission is, "To provide innovative, clean and energy-efficient solutions for a better tomorrow." Delta is committed to environmental protection and has implemented green, lead-free production and recycling and waste management programs for many years.

More information about Delta Group can be found at www.deltaww.com



About MCIS

With its expertise and experience in power management and energy efficiency, the Mission Critical Infrastructure Solutions (MCIS) business of Delta Electronics Inc. positions itself as: "The power behind competitiveness". MCIS plays an important role in making our customers' businesses more competitive. We fulfill this role by providing highly reliable and efficient power management products and datacenter infrastructure solutions to ensure the continuity of our customers' mission critical operations while reducing their Total Cost of Ownership (TCO). Delta MCIS is a powerful and trustworthy partner to companies that strive to outperform the competition.

With more than 15 years of experience in the UPS industry, Delta Electronics is a leading brand, featuring complete professional capacities ranging from product development, design and manufacturing for all UPS product lines. Our client base covers world class enterprises in the areas of semiconductors, optoelectronics, food processing, finance, petrochemicals and telecommunications. Additionally, our UPS solutions have been adopted extensively at major Asia events in recent years, including the World Expo 2010 Shanghai, the Guangzhou Asian Games and Universiade Shenzhen, just to name a few. Delta's UPS solutions play a critical role in power management for a number of public mega projects, including One of the major transportation system in Taiwan, that has been rated number one in reliability by Nova/CoMet five years in a row since 2004, and the recently launched Target Spacecraft in China. The most competitive companies in the world choose Delta because our products are designed to enhance competitiveness.



Delta UPS

Our clients are most concerned about power issues such as power failure, power sag, power surge, under voltage or over voltage, frequency variation, harmonic distortion and line noise. Delta Electronics emphasizes the areas of redundant power supply, voltage regulation, equipment protection and adjustment and has designed and developed three UPS product families - Agilon, Amplon, Ultron and Modulon. Their power range, applications and the equipment they protect are listed below:

Product Family	Power	Topology	Applications
Agilon	Under 1kVA	Single-Phase UPS	PC and Peripherals
Amplon	1kVA or higher	Single-Phase UPS	Server and Network Equipment
Ultron	10kVA or higher	Three-Phase On-Line UPS	Datacenter and Industrial Equipment
Modulon	20kVA or higher	Three-Phase Modular On-Line UPS	Modular unit expansion and redundant power supply can be achieved within a single rack.

Delta UPS systems feature the following:

- Leading AC-AC Efficiency
- Fully redundant design and configuration
- High input and output power factors
- Easy expansion without additional hardware
- Supports to seamless operations at low level of TCO (Total Cost of Ownership)



Customers can choose suitable UPS systems based on their needs to maintain seamless operations and ensure their long term competitiveness.

Agilon Family

In the Delta UPS product line, the Agilon family are single phase UPS systems for power rating requirements under 1kVA, that can support PC products, peripherals and small POS systems. The word Agilon (Agile + on), denotes agility and precision, which describe the features of this UPS system – small yet efficient; they are the perfect power management solution for residential users, SOHO workers or small enterprises.

Amplon Family

In the Delta UPS product line, the Amplon family are single phase UPS systems for power rating requirements above 1kVA that support medium to small network devices, security and surveillance systems and POS systems. The word Amplon (Ample + on), represents ample stability, which describes this UPS system – it maximizes space and economic benefits. Amplon systems are the perfect power management solution for small to medium enterprises, such as financial institutes, government departments and medical centers, and offer the power protection solution with the highest space and cost benefits.

Ultron Family

In the Delta UPS product line, the Ultron family are three-phase UPS systems for power rating requirements above 15kVA that support mission critical applications including industrial equipment, datacenters, traffic control facilities, broadcast stations and backbone networks. The word Ultron (Ultra + on), signifies ultimate performance, which describes the features of this UPS system – outstanding stability and insurance for mission critical applications.

Modulon Family

In the Delta UPS product line, the Modulon family features a three-phase modularization architecture for power rating requirements above 20kVA and supports datacenters, mid-large network equipments, data storage centers and financial balance centers. The word Modulon (Modular + on) highlights its core feature – modularization. Customers can purchase UPS systems with greater flexibility based on their initial unit needs and future needs for scalability to lower their TCO and maximize system benefits.

UPS Management Applications and Supported NIC Cards

In addition to high efficiency and reliable UPS systems, Delta Electronics also offers the following value added services: UPSentry and InsightPowerUPS management applications. By adding supported NIC cards, customers can remotely monitor UPS operations, perform initial diagnoses on abnormal conditions and power on or off the control systems remotely when necessary.

Delta UPS - Agilon Family



SX Series, Single Phase Stand-by 600VA

The Agilon SX Series Stand-by UPS is the best power protection product specially designed for personal computers, peripherals and POS. It can be used by families and in personal workshops and office environments. When there's a situation of abnormal power outage or unstable voltage, it provides backup power, allowing computers, gaming devices or other equipment to continue operating normally without being interrupted. The Agilon SX Series Stand-by UPS can also suppress damages that may arise due to power surges and serves as the comprehensive power protection.

Applicable Sectors



PC



Fax



Monitor



ADSL



Home



POS

Features:

- Wide input voltage range reduces battery discharging occurrence and prolongs battery life.
- Battery-start function when utility power is not present.
- LED indicators provide the UPS status at a glance.
- Audible alarms provide indication of UPS and utility power conditions.
- Provide 24/7 protection from surge, lightning and other power events.
- Overload and over-charge protection.
- Well-designed microprocessor control provides higher reliability.

Note: Available in South America and Taiwan

Delta UPS - Agilon Family



VX Series, Single Phase 600VA

The Agilon VX line-interactive UPS is a best value product designed for PCs, laptops, and POS equipment used in home offices and small businesses. Friendly LED indicators display real-time power and UPS status that users can see in a glance. Automatic voltage regulation (AVR) ensures all electronics are receiving stable power while providing higher availability. Even under severe power conditions, the wide input voltage range of the Agilon VX can adapt and reduce the probability of using the battery.

Applicable Sectors



PC



Fax



Monitor



ADSL



Home
Appliances



POS

Features:

- Wide input voltage range reduces battery discharging occurrences and prolongs battery life.
- Automatic voltage regulation (AVR) delivers stable voltage and provides higher availability.
- Smart charger shortens battery recharging time.
- Battery-start function when utility power is not present.
- UPS is able to restart automatically while utility power is recovering.
- Automatic battery charging in off mode.
- LED indicators provide the UPS status at a glance.
- Audible alarms provide indication of UPS and utility power conditions.
- Automatic self-test ensures battery condition.
- Provides 24/7 protection from surges, lightning and other power events.
- Equipped with network line RJ45 surge protection.
- Overload and over-charge protection.
- Surge protection outlet for less-essential equipment.
- Well-designed microprocessor control provides higher reliability.

Note: Available in India

Delta UPS - Amplon Family



M Series, Single Phase

1/1.5/2/3 kVA

The Amplon M series is a line-interactive UPS providing sine-wave quality ideally suited for devices in small and medium businesses. Automatic voltage regulator (AVR) delivers stable voltage while providing higher availability. It is available in either rack or tower configuration to fit multiple applications such as servers, networking, VoIP and telecommunications. The Amplon M features excellent normal mode efficiency and high output power factor, resulting in a greater power supply for critical loads at significantly less operating cost.

Applicable Sectors



Server



Telecom



Industrial



Network



VoIP



Storage



Medical

Features:

- Hot swappable battery pack for easy maintenance.
- Automatic voltage regulator (AVR) delivers stable output voltage.
- Input voltage range meets the needs of most applications and avoids frequent transfers to battery mode to help prolong battery life.
- Battery starts when utility power is not present.
- Self test for battery replacement warning.
- Rack or tower configuration in 2U size cabinet.
- Optional external battery pack (applicable for 3kVA model) for extendable backup time.
- Communication slot for various smart cards to support various applications.
- Intelligent management software connectivity via RS232 or USB port.
- High output power factor 0.9 provides more real power to critical loads.
- High efficiency online mode can reach 97% for 1/1.5kVA and 96% for 2/3kVA for greater operating cost savings.

Note: Available in ET (Europe and Turkey) and MEA (Middle East and Africa)

Delta UPS - Amplon Family



E Series, Single Phase 1/2/3 kVA

The Amplon E series is a true on-line, double-conversion UPS housed in a compact tower and recommended for workstations, POSs, ATMs and home appliance. The Amplon E series is designed for long backup time applications with the addition of a battery source. An inbuilt high level charger shortens the recharging period and increase the availability.

Features:

- Double-conversion technology provides 24/7 full-time protection.
- Automatic input frequency(50 or 60 Hz, auto-detection).
- AC-start and battery-start capabilities.
- Input voltage bears up to 330 Vac. Suitable for severe utility conditions.
- High charging capability increases availability.
- Suitable for long backup time applications with customized battery source.
- Optional external battery pack for longer backup time.
- Smart slot for mission critical applications.
- High input power factor (pf > 0.97) saves installation costs.
- Wide input voltage range and stable power supply extends battery life.

Applicable Sectors



Server



Network



Security



Medical



POS



Banking

Note: Available in India and China

Delta UPS - Amplon Family



N Series, Single Phase

1/2/3 kVA

The Amplon N series is a true on-line, double-conversion UPS housed in a compact tower. It is designed to eliminate disturbances and supply superior power quality to workstations, POSs, ATMs or home appliances.

The Amplon N series has inbuilt batteries to provide continuous and stable power to critical loads when power events occur. For longer backup time requirements you can add an external battery pack to enhance availability.

Applicable Sectors



Server



Network



Security



Medical



POS



Banking

Features:

- Double-conversion technology provides 24/7 full-time protection.
- Battery-start capability without utility power.
- Automatic bypass ensures continuous output power when fault occurs.
- Automatic input frequency detection.
- Optional external battery pack for longer backup time.
- RS232 port with power management software.
- Input voltage range meets the needs of most applications and avoids frequent transfers to battery mode to help prolong battery life.
- Intelligent management prevents battery from over-discharge.

Delta UPS - Amplon Family



R Series, Single Phase

1/2/3 kVA

The Amplon R series is a true on-line, double-conversion UPS that protects devices from potential power problems such as spikes, surges and brownouts. It is available in either a rack or tower configuration and is recommended for servers, VoIP, telecommunications and networking.

The Amplon R series is designed for long backup time applications with the addition of a customized battery source.

The inbuilt high level charger shortens the recharging period and increases availability.

Applicable Sectors



Server



Telecom



Industrial



Network



VoIP



Storage



Medical

Features:

- Double-conversion technology provides 24/7 full-time protection.
- Automatic input frequency detection.
- Additional charger board can be added for long backup applications and reduced recharging time.
- AC-start and battery-start capabilities.
- Rail kit is included in the package.
- Rack or tower configuration in 2U size cabinet.
- Fulfill long backup time demand for mission critical applications.
- Remote management over network via software.
- High input power factor (pf > 0.97) saves installation cost.
- Input voltage range meets the needs of most applications and avoids frequent transfers to battery mode to help prolong battery life.

Delta UPS - Amplon Family



Applicable Sectors



Server



Telecom



Industrial



Network



VoIP



Storage



Medical

GAIA Series, Single Phase

1/2/3 kVA

The Amplon GAIA series is a true on-line, double-conversion UPS designed in a rack or tower configuration and recommended for servers, VoIP, telecommunications and networking. This versatile UPS combines features such as full-time protection and high input power factor in the small footprint of a 2U cabinet.

The Amplon GAIA series UPS has inbuilt batteries to provide continuous and stable power to your critical loads when power events occur. With an external battery pack, it can fulfill longer backup time requirements.

Features:

- Double-conversion technology provides 24/7 full-time protection.
- Built-in batteries for basic runtime demands.
- Battery-start capability without utility power.
- RS232 and USB connectivity with power management software.
- Built-in data line surge protector for phone/fax/network.
- Rack or tower configuration in 2U size cabinet.
- Optional external battery pack for longer backup time.
- SMART slot for remote management.
- Programmable output saves energy for important loads.
- Input voltage range meets the needs of most applications and avoids frequent transfers to battery mode to help prolong battery life.
- High input power factor (pf > 0.97) saves installation cost.
- Intelligent management prevents battery from over-discharge.

Note: Not available in China and India.

Delta UPS - Amplon Family



RT Series, Single Phase

5/6/10 kVA

The Amplon RT series delivers double-conversion on-line technology, high power density and input power factor, and low current harmonics with its advanced architecture. Designed in a rack or tower configuration with an LCD display, Amplon RT offers advanced performance for servers, data centers, networking, VoIP and telecommunications.

The Amplon RT has 1+1 parallel redundancy function to provide higher reliability. Optional external battery pack can be added to fulfill longer backup time for mission critical applications.

Applicable Sectors



Server



Telecom



Industrial



Network



VoIP



Storage



Medical

Features:

- True online double-conversion topology provides 24/7 full-time protection.
- 1+1 parallel redundancy or expansion without requiring additional hardware.
- AC-start and battery-start capabilities.
- Additional charger board can be added to reduce recharging time.
- Optional maintenance bypass box for parallel redundancy with manual bypass switch.
- External charger box enhances battery charging ability.
- Rack or tower configuration.
- Multi-language LCD display with blue backlight.
- Optional external battery pack for longer backup time.
- Output factor 0.9 delivers more real power.
- High input power factor (pf > 0.99) and low harmonic distortion (iTHD < 5%).
- Common battery installation enables two UPS in parallel to share one battery source for cost savings.
- Input voltage range meets the needs of most applications and avoids frequent transfers to battery mode to help prolong battery life.

Delta UPS - Amplon Family



Applicable Sectors



Data Center



Network



Security



Medical



Industrial



Banking

N Series, Single Phase 6-12 kVA

The Amplon N series is a true on-line, double-conversion UPS designed for workstations, POS, ATMs, home appliances, small server rooms or production equipment.

Features:

- Single phase 110/220 Vac dual output power supply
- Wide input range (120V-280V)
- High overall efficiency (>88%), 94% under Eco Mode
- High input power factor (>0.99) for greater power utilization rate
- Ideal as hot-standby to increase system reliability
- Class H output isolation transformer design
- Built-in maintenance switch
- Convenient control panel and LCD indicator
- Support REPO (remote emergency power off) function
- Optional external battery to extend standby duration
- Centralized remote monitoring possible with Vista-compatible power management applications

Note: Available in South America and South East Asia (excluding India)

Delta UPS – Ultron Family



EH Series, Three Phase In - Single Phase Out 10/15/20 kVA

The Ultron EH series is an online double-conversion 3p-1p UPS which provides reliable power protection for IT rooms, telecommunications, banking, medical facilities and industry. Supported with DSP based technology, it offers rapid computation capabilities that enhance system stability and provide precise voltage to load. The Ultron EH series offers many superior features including N+X parallel redundancy and a built-in manual bypass switch to guarantee higher availability and reliability for protecting your critical loads.

Applicable Sectors



Data Center



Telecom



Industrial



Network



Security



Lab



Medical



Metro



Banking



Retail

Features:

- True online double-conversion technology to completely protect the critical load from problems occurring on the source side.
- DSP based technology to support rapid computation capability and a simplified control circuit for enhanced stability.
- Dual input design to allow different power supply sources for enhanced availability.
- Built-in manual bypass ensures continuous power to the load during maintenance.
- A wide input voltage range to reduce battery discharge probability and prolong battery life.
- ECO mode efficiency up to 96% to reduce operating cost
- Small footprint to save space.
- Parallel expansion and N+X redundancy up to 4 units without requiring additional hardware.
- Additional internal charger and external charger box provide flexible capacity expansion.
- Remote and local emergency power-off functions (EPO) to promptly manage the UPS when emergencies occur.
- Multi-connectivity interface to support remote UPS monitoring and management.
- Advanced management software to provide event alert management, remote shutdown, event log tracking and analysis.
- Reliable battery management for better battery protection.

Delta UPS – Ultron Family



HPH Series, Three Phase 20/30/40 kW

The Ultron HPH is a true online double-conversion UPS offering the best-in-class combination of maximum available power, unbeatable energy efficiency and superior power performance for small data centers and other mission critical applications requiring highly reliable power protection. With fully rated power (kVA=kW); the Ultron HPH provides maximum available power without de-rating the UPS. Thanks to Tripple level inverter and Delta’s innovative Three Phase PFC topology, it features low iTHD <3%, up to 96 % AC-AC efficiency and 99% efficiency in ECO mode resulting in significant TCO (Total Cost of Ownership) savings. Facilitating increased availability through special watch-dog design, the Ultron HPH is an ideal solution for protecting your mission critical operations.

Applicable Sectors



Data Center



Telecom



Industrial



Network



Security



Lab



Medical



Metro



Banking

Features:

- Fully rated power (kVA=kW) for maximum available power.
- Leading AC-AC efficiency up to 96% saves energy costs.
- Low harmonic pollution (iTHD<3%) reduces upstream investment costs.
- Wide input voltage range allows the UPS to operate in unstable electrical environments and extends battery life.
- DSP based technology enables reduction in the number of electronic components to lower failure rate.
- Redundant auxiliary power enhances system reliability.
- Watch-dog design of dual auxiliary power circuit to eliminate single-point failure to ensure reliability.
- Built-in manual bypass ensures continuous power to the load even if the UPS is under maintenance.
- A wide choice of configurations, such as N+X redundancy, and hot stand-by.
- Adjustable charging current and battery voltage meet different battery configuration requirements.
- Flexible arrangement of battery quantity from 34 to 50 pcs optimizes battery investment.
- Multi-connectivity interface supports remote UPS monitoring and management.
- Advanced management software provides remote shutdown, event log tracking and analysis.

Delta UPS – Ultron Family



Applicable Sectors



Data Center



Telecom



Industrial



Network



Security



Lab



Medical



Metro

NT Series, Three Phase 20-500 kVA

The Ultron NT series is a three phase UPS featuring customized I/P-O/P ratings for various applications. With N+X parallel redundancy or expansion, it guarantees high availability and reliability for your critical loads.

The Ultron NT series offers continued seamless protection for your business even under 100% unbalanced loading conditions. Its economy mode improves efficiency and saves operating cost.

Features:

- Available from 20 to 4,000 kVA (8 x 500 kVA in parallel).
- Parallel redundancy without requiring extra hardware to increase reliability.
- Built-in isolation transformer protects user equipment.
- Optional harmonic filter and 12-pulse rectifier.
- Redundant auxiliary power and control circuit ensures higher reliability.
- Inbuilt maintenance and static bypass switch.
- Multi-language LCD display and LED status indicators.
- RS232, RS485 and six programmable dry contact outputs.
- Compatible with generator installation and unbalanced loads.
- Optional external battery cabinet for longer backup time.
- Parallel expansion as your business grows and consequently saves initial investment.
- Wide input voltage range extends battery lifetime.
- Economy mode saves energy and operating cost.
- Common battery installation saves initial investment.

Delta UPS – Ultron Family



Applicable Sectors

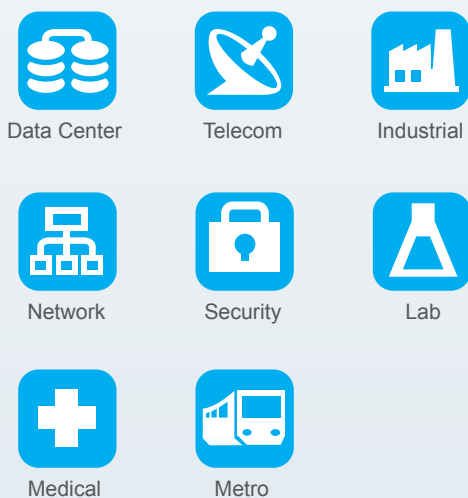

DPS Series, Three Phase

60-400 kVA

Delta's Ultron DPS is a double-conversion and IGBT-rectifier three phase UPS. With state-of-the-art TLI (Triple Level Inverter) and three phase PFC (power factor correction) topology, the Ultron DPS features industry leading performance of up to 96 % AC-AC efficiency, input power > 0.99, Low iTHD < 3%, and output power factor up to 0.9. Aiming to achieve the highest availability possible, Delta has enhanced the designs for battery management, swappable fans and ease of maintenance.

The excellent power performance and high system availability of the Ultron DPS provide customers with the benefits of a stable power supply, high power efficiency, low capital investment and low overall operation cost.

Features:

- N+X redundancy or hot-standby configuration increases system reliability
- Wide input voltage range (DPS 60-120kVA : -45% ~ +20% , DPS 160- 400kVA : -40% ~ +20%) allows the UPS to work in unstable electrical environments
- Field programmable sequential start-up
- Intelligent fan speed control and redundant fan design prevent overheating
- Comprehensive battery management sustains battery lifetime and optimal operation
- High efficiency even at light load saves operating costs
- High input power factor (> 0.99) and low input harmonic distortion (iTHD < 3%) save upstream investment
- Parallel expansion without extra hardware allows quick capacity upgrade to meet business growth
- Swappable fans reduce maintenance time
- Built-in manual bypass allows "zero downtime" to ensure system availability during service maintenance
- Main I/P, O/P and bypass switches detection provide quick diagnosis when faults occur

Delta UPS – Modulon Family



NH Plus Series, Three Phase 20-120 kVA

The Modulon NH Plus series is Delta's modular UPS featuring high efficiency, hot-swappable modular structure and N+X redundancy. With its high efficiency, the NH Plus series delivers remarkably low total cost of ownership in terms of both capital expense and operating expense.

With N+X module and system redundancy to guarantee reliability and availability, the Modulon NH Plus series is an excellent UPS solution to protect the mission critical applications.

Applicable Sectors



Data Center



Telecom



Industrial



Network



Security



Lab



Medical



Metro

Features:

- Available from 20 to 480 kVA (4 units x 120 kVA in parallel).
- Redundancy at module and system level.
- Hot-swappable function ensures uninterrupted operations during maintenance.
- Redundant auxiliary power and control circuit ensures higher reliability.
- Inbuilt maintenance and static bypass switch.
- Modular design provides easy maintenance and scalability.
- Multi-language LCD display and LED status indicators.
- Two SMART slots and six programmable dry contact outputs.
- Optional external battery cabinet for longer backup time.
- Low harmonic distortion (iTHD<3%) optimized generator size to save initial investment.
- High input and output power factor (I/P PF >0.99; O/P PF up to 0.9) and 94% high efficiency reduce operating costs.

Delta UPS – Modulon Family



Applicable Sectors



Data Center



Telecom



Industrial



Network



Security



Lab



Medical



Metro

NHV Plus Series, Three Phase 40-120 kVA

The Modulon NHV Plus series is Delta's modular UPS featuring high efficiency, hot-swappable modular structure and N+X redundancy. With its industry leading 94% high efficiency, the NHV Plus series delivers remarkably low total cost of ownership in terms of both capital expense and operating expense.

With N+X module and system redundancy to guarantee reliability and availability, the Modulon NHV Plus series sets a new milestone for UPS protection in mission critical applications.

Feature:

- Available from 40 to 240 kVA (2 units x 120 kVA in parallel).
- Redundancy at module and system level.
- Hot-swappable function ensures uninterrupted operations during maintenance.
- Redundant auxiliary power and control circuit ensure higher reliability.
- Inbuilt maintenance and static bypass switch.
- Modular design provides easy maintenance and scalability.
- Multi-language LCD display and LED status indicators.
- Two smart slots and six programmable dry contact outputs.
- Optional external battery cabinet for longer backup time.
- Low harmonic distortion (iTHD<3%) optimized generator size to save initial investment
- High input and output power factor (I/P pf >0.99; O/P pf up to 0.9) and 94% high efficiency reduce operating costs

Delta UPS – Modulon Family



DPH Series, Three Phase 25-200 kW

The Modulon DPH supports ultimate availability for datacenter operations and provides the benefit of “pay as you go” without over-sizing the UPS. While achieving ultimate availability, the Modulon DPH does not compromise on power efficiency performance. When availability, efficiency and expanding according to business needs are essential, the Modulon DPH is the ideal UPS system to provide power protection and total cost of ownership (TCO) savings.

Features:

- Advanced fault tolerance design achieved by self redundancy to guarantee operation continuity.
- Self-synchronization of power and control modules for continuous on-line operation even in the event of control module failure to avoid downtime caused by single point failure.
- Hot-swappable key modules and components to ensure Mean Time To Repair (MTTR) close to zero without downtime risk.
- Vertical expansion from 25kW to 200kW supporting N+X redundancy in a single rack enclosure to save footprint.
- Parallel expansion up to four units without requiring additional hardware.
- Variable configurations possible providing the scalable flexibility up to Tier 4 level.
- Full rated power (kVA=kW) to maximize power availability.
- High operating efficiency of 95% at 30% load and 96% from 50% load resulting in marked energy cost savings.
- Low harmonic pollution (iTHD<3%) to reduce upstream investment costs and meet demanding power requirements.
- Built-in manual bypass features to eliminate maintenance-related downtime.
- Proactive detection of fan failure and switch fault for early diagnosis on UPS malfunction.
- Plug and play modularity to simplify the maintenance process.

Applicable Sectors



Data Center



Telecom



Industrial



Network



Security



Lab



Medical



Metro



Banking

Product Application Matrix

	Agilon		Amplon						
	SX Series 0.6 kVA (off-line)	VX Series 0.6 kVA (line- interactive)	E Series 1/2/3 kVA (on-line)	M Series 1-3 kVA (line- interactive)	N Series 1-3 kVA (on-line)	N Series 6-12 kVA (on-line)	R Series 1-3 kVA (on-line)	GAIA Series 1-3 kVA (on-line)	RT Series 5-10 kVA (on-line)
Configuration 1:1	O	O	O	O	O	O	O	O	O
Configuration 3:1									
Configuration 3:3									
Rack mountable				O			O	O	O
Stand-alone	O	O	O	O	O	O	O	O	O
Isolation transformer						O			
Battery †	I	I	E	I,E	I, E	I, E	E	I	E
Home and office *	O	O	O	O	O			O	
Small enterprise, IT and medical **				O	O	O	O	O	O
Medium enterprise, telecom, IT, media ***						O			O
Heavy industry, telecom, IT, Industrial ****									

† I: internal battery, E: external battery

* PCs, laptops, modems, printers, WiFi and audio equipment

** Computers, servers, networking, medical control and diagnostics, education, banking, industrial automation

*** Telecom base stations, data centers, backbone networks, broadcasting, projection systems

**** Telecom centers, data centers, medical equipment at hospitals, government use, automatic control, oil, gas and power utilities, industrial equipment, automation and control

Product Application Matrix

	Ultron				Modulon		
	EH Series 10-20 kVA (on-line)	HPH Series 20-40 kW (on-line)	NT Series 20-500kVA (on-line)	DPS Series 60-400kVA (on-line)	NH Plus Series 20-120kVA (on-line)	NHV Plus Series 40-120 kVA (on-line)	DPH Series 25-200kW (on-line)
Configuration 1:1							
Configuration 3:1	O		O				
Configuration 3:3		O	O	O	O	O	O
Rack mountable							
Stand-alone	O	O	O	O	O	O	O
Isolation transformer			O	O			
Battery ' 	E	I, E	E	E	E	E	E
Home and office *							
Small enterprise, IT and medical **	O	O					
Medium enterprise, telecom, IT, media ***	O	O	O	O	O	O	O
Heavy industry, telecom, IT, Industrial ****	O	O	O	O	O	O	

' I: internal battery, E: external battery

* PCs, laptops, modems, printers, WiFi and audio equipment

** Computers, servers, networking, medical control and diagnostics, education, banking, industrial automation

*** Telecom base stations, data centers, backbone networks, broadcasting, projection systems

**** Telecom centers, data centers, medical equipment at hospitals, government use, automatic control, oil, gas and power utilities, industrial equipment, automation and control

UPS Management

SNMP Card



Functions and features

■ Network

SNMP	SNMPv1 protocol support; accepts NMS monitoring as well as actively sends Trap packets to target hosts
HTTP	Monitor and set up through network browser with built-in web server
Others	Telnet, TFTP, FTP, BOOTP, SMTP, SNTP, DHCP and WOL
MIB	Supports RFC1628 and Delta proprietary UPSv4 MIB

■ Management

Regular power on and off	Can set up UPS power on and off time
Regular testing	Battery discharge test to ensure the battery is in good condition
Smart power off	Can send power off signal to connected host actively if the host computer has the InsightPower Client or SNMP power off proxy installed
Probe	Optional environment probe can integrate ambient temperature and humidity for total cabinet monitoring

■ Diagnosis

Event log	Keep date, time, and event sequence in event log file
History records	Keep date, time, and UPS parameter data. Can be exported into XLS file for further processing

■ Reaction to events

UPS shutdown	Define delay time for UPS power off to avoid deep discharge
Email	Send email notification to predefined recipients in case of power event

Technical specifications

10 / 100M RJ45 connector

Operation temperature	0 ~ 40°C
Input power	9 ~ 24 Vdc
Power consumption	< 1W
Dimensions	130 x 60 mm
Weight	58 g

SNMP IPv6 Card



Functions and features

■ Network

SNMP	SNMPv1/v3 protocol support; accepts NMS monitoring as well as actively sends Trap packets to target hosts
HTTP/HTTPS	Support IPv4 and IPv6 TCP/IP protocol Monitor and set up through network browser with built-in web server
Others	Telnet, SSH, FTP, SFTP, BOOTP, DHCP, SMTP, SNTP, WOL and RADIUS, Syslog
MIB	Supports RFC1628 and Delta proprietary UPSv4 MIB, UPSv5 MIB

■ Management

Regular power on and off	Can set up UPS power on and off time
Regular testing	Battery discharge test to ensure the battery is in good condition
Smart power off	Can send power off signal to connected host actively if the host computer has the InsightPower Client or SNMP power off proxy installed
Probe	Optional environment probe can integrate ambient temperature and humidity for total cabinet monitoring

■ Diagnosis

Event log	Keep date, time, and event sequence in event log file
History records	Keep date, time, and UPS parameter data. Can be exported into XLS file for further processing

■ Reaction to events

UPS shutdown	Define delay time for UPS power off to avoid deep discharge
Email	Send email notification to predefined recipients in case of power event

■ Application

Integrate the communication requirement of UPS, PDC, STS, ATS and cooling with dip switches selection in one single SNMP IPv6 card

Technical specifications

10 / 100M RJ45 connector

Operation temperature	0 ~ 60° C
Input power	12 Vdc
Power consumption	< 2W
Dimensions	130 X 60 mm
Weight	75 g

EnviroProbe



Functions and features

- LCD display
- Ambient temperature & humidity monitoring and water-leakage detection
- Digital & analog input/output contacts for monitoring and controlling other devices
- Supports both RS232 or RS485 communications
- Supports SNMP communications protocol
- InsightPower Manager software for remote monitoring and recording

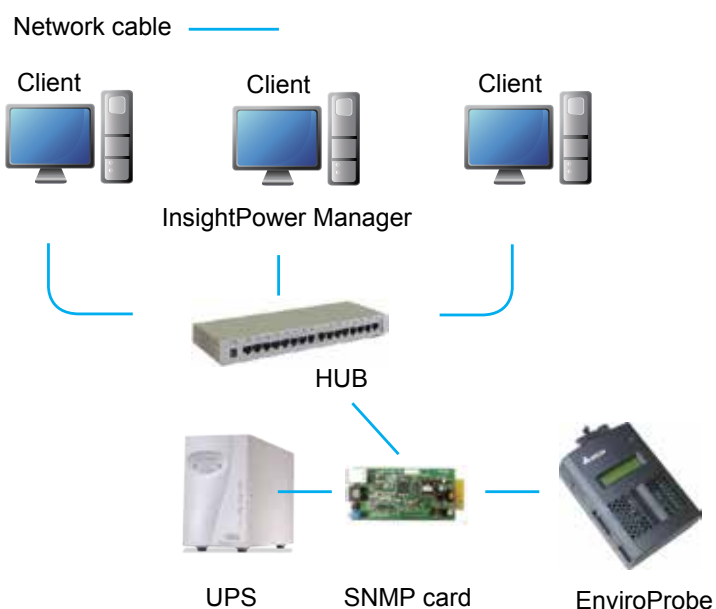

Technical specifications

Model	EMS1000	EMS1100	EMS1200
Input	Connect to UPS SNMP card: 12Vdc (pin 1 & 4) with PDU SNMP card: 5Vdc (pin 2 & 4)		
Input/Output Contacts	4 inputs (dry/wet)	4 digital outputs	2 analog inputs, 1 analog output and 1 water-leakage detection.
Dimensions (W x D x H)	66 x 30 x 99 mm	66 x 33 x 103 mm	
Weight	120g	130g	
Temperature	±1°C @ 15 ~ 35°C ±2°C @ 0 ~ 15°C and 35 ~ 45°C	n/a	
Humidity accuracy	± 10% from 15 ~ 35°C		n/a
Safety regulation compliance	CE, EN55022 Class B, EN55024		

UPS Management

Relay I/O card



Technical specifications

Operation temperature	0 ~ 40°C
Input power	8 ~ 20 Vdc
Power consumption	< 1.2W
Dimensions	130 x 60 mm
Weight	200g

Functions and features

■ Output

- Programmable 6 output relays, each of them can be configured to represent one of the 20 UPS events respectively
- NC/NO 6 output relays, each of them can be configured to either NC (Normal Close) or NO (Normal Open)

■ Input

- Programmable The input signal can be configured to turn off the UPS or to issue battery test command

Modbus card



Technical specifications

Operation temperature	0 ~ 40°C
Input power	8 ~ 20 Vdc
Power consumption	< 1.2W
Dimensions	130 x 60 mm
Weight	150g

Convert status and parameter data of your UPS to comply with the standard Modbus protocol

Functions and features

- Communications interface 1 x RS232 port; 1 x RS485 or RS422 port
- ID Device ID can be set to any number between 0~255
- Terminating resistor Terminating resistance of RS485 / 422 can be set by dip switch
- Modbus communications format Supports RTU format
- Baud rate 2400, 4800, 9600 or 19200
- Data bit 7 or 8
- Parity check None, even or odd

Mini SNMP Card



Functions and features

■ Network

SNMP	SNMPv1 protocol support; accepts NMS monitoring as well as actively sends Trap packets to target hosts
HTTP	Monitor and set up through network browser with built-in web server
Others	Telnet, TFTP, FTP, BOOTP, SMTP, SNTP, DHCP and WOL
MIB	Supports RFC1628 and Delta proprietary UPSv4 MIB

■ Management

Regular power on and off	Can set up UPS power on and off time
Regular testing	Battery discharge test to ensure the battery is in good condition.
Smart power off	Can send power off signal to connected host actively if the host computer has the InsightPower Client or SNMP power off proxy installed

■ Diagnosis

Event log	Keep date, time, and event sequence in event log file
History records	Keep date, time, and UPS parameter data. Can be exported into XLS file for further processing

■ Reaction to events

UPS shutdown	Define delay time for UPS power off to avoid deep discharge
Email	Send email notification to predefined recipients in case of power event

Technical specifications

Network connection	RJ-45 jack connector
Operation temperature	0 ~ 40° C
Input power	3.3 Vdc
Power consumption	1 Watt Maximum
Dimensions	60.5 x 40 mm
Weight	30 g

UPS Management

Mini USB Card



Functions and features

- Communication Protocol
SCI: Delta Regular v1.51
USB: Delta HID Protocol v3.4
- Support HID (Human Interface Device) protocol
The UPS can communicate with Windows XP/2003/2008/2012/Win7/Win8 without monitoring software
- Compatible with Delta UPS standard software: UPSentry 2012

Technical specifications

Dimensions	68 x 43 mm
Weight	30 g
Operating temperature	0 ~ 40° C
Input power	12 Vdc
Power consumption	0.5 Watts

Mini Dry Contact Card



Functions and features

- UPS status information presented as 3 contact closures
- Configurable input signal as shutdown UPS or battery test
- Programmable output contact to monitor status of UPS
- Configurable UPS shutdown delay time
- Protects up to 3 computers
- Unattended graceful shutdown

Technical specifications

Dimensions	68 X 43 mm
Weight	35g
Operating temperature	0 ~ 40° C
Input power	8 ~ 20 Vdc
Power consumption	0.8 Watts

Mini TVSS Card



Functions and features

- This connection is optional but highly suggested as network lines often carry dangerous surges and spikes
- Connect the Network Protection Lines
Connect the network line from the wall to the connector marked “IN”, then connect the device (Ethernet card) to be protected to the connector marked “OUT”

Technical specifications

Dimensions	46 x 43 mm
Weight	25g
Operating temperature	0 ~ 40° C

Delta UPS Management Software

Communications mechanism

	RS232	USB	RS485	SNMP
InsightPower Client				•
UPSentry 2012	•	•		
InsightPower Manager	•		•	•
ShutdownAgent 2012				•

Key functions

	Shutdown OS	Centralized management	Remote control	Virtual Machine Shutdown			
				Hyper-v	ESXi	XenServer	KVM
InsightPower Client	•		•				
UPSentry 2012	•		•	•		•	•
InsightPower Manager		•	•				
ShutdownAgent 2012	•			•	•	•	•

Operating system support

	Windows	Linux	FreeBSD	Sun Sparc
InsightPower Client	•			
UPSentry 2012	•	•	•	•
InsightPower Manager	•			
ShutdownAgent 2012	•	•	•	•

UPS Management

InsightPower Manager

Functions and features

- Centralized UPS management system
- Supports RS232, RS485 and network SNMP communications
- Supports backend database connections
- Hierarchical design for limitless connection nodes
- Configurable response action
- SNMP card setup in batch
- Remote and local UPS on-the-spot monitoring and management
- Provides statistical reports
- Can set up timed power on/off and testing time
- Supports inquiring events and historical data in database from other workstations with the accompanying InsightPower Manager Client program



Operating system support

- Supports Microsoft Windows, 2000, XP, 2003, Vista, Win7, 2008
- Diagrammatic sketch of operating system :

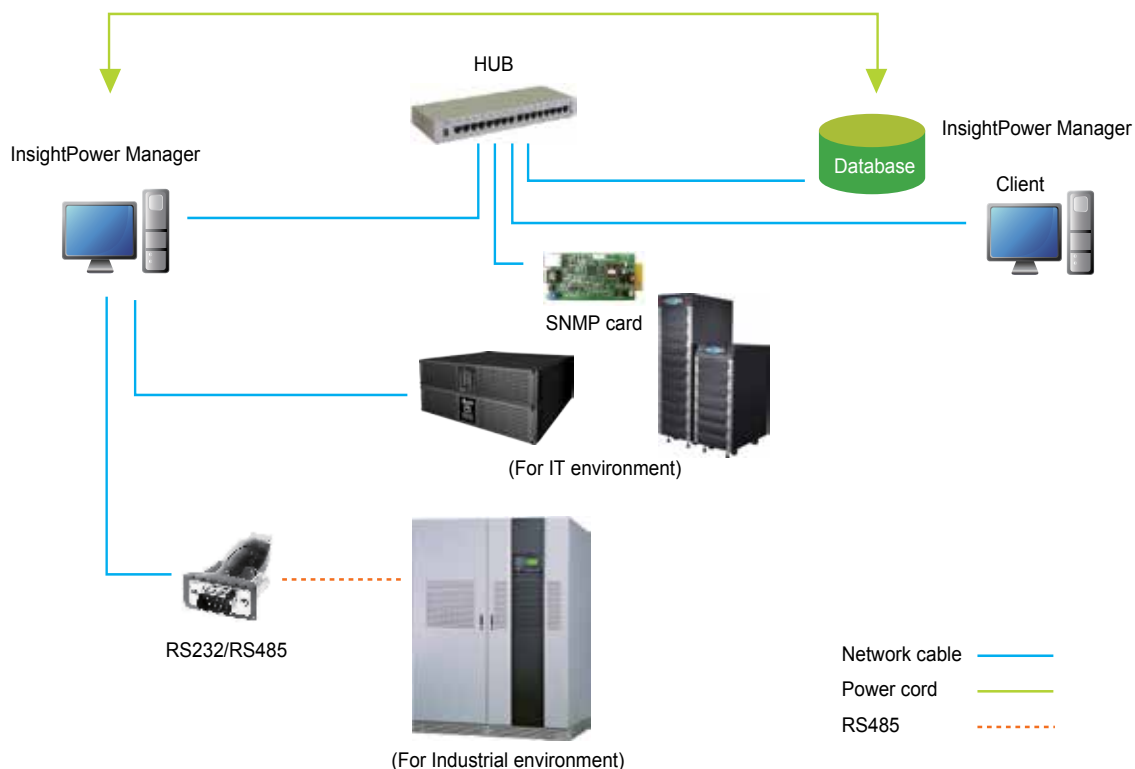

Display

- Table: Displays UPS status in all or by group
- Hierarchical graph: Displays location of UPS object for fast review of status indicator, block diagram and real time data in selected region

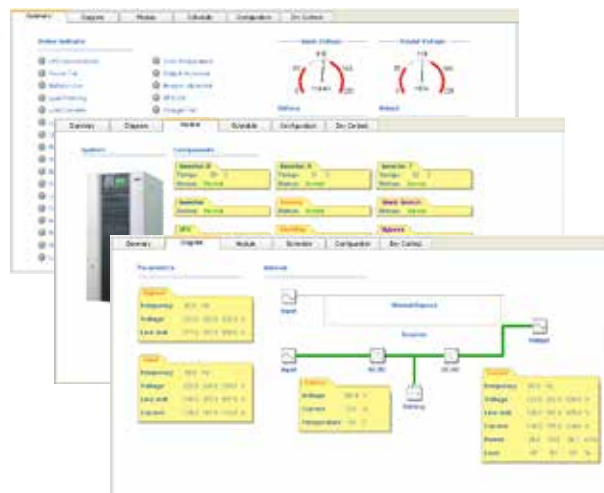

Responsive actions

- Event log
- Network broadcasting
- Voice alert
- Email
- SMS

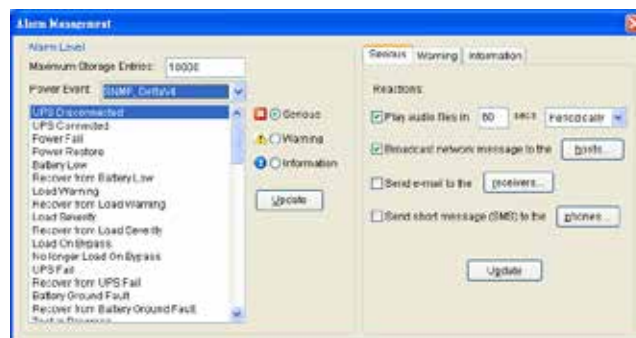

Event tracking

- Log UPS events and operation record in sequence of date and time
- Supports historical data and curve display as well as exporting as files in Excel format
- Supports statistical report generation in a specified time range

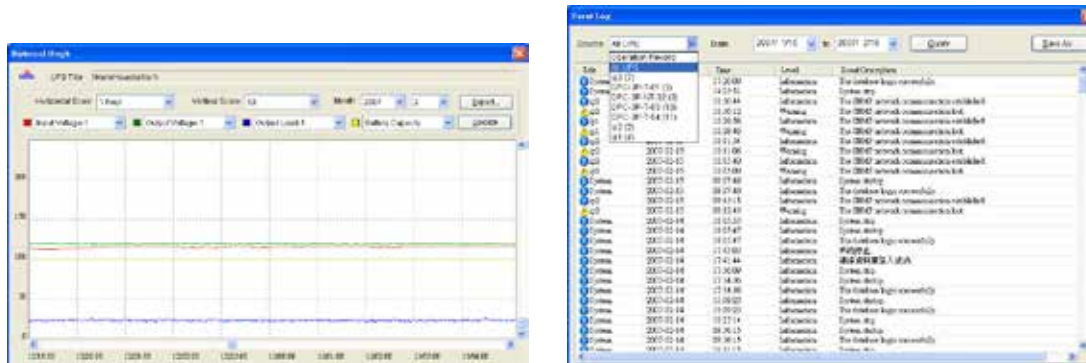

UPS Management

InsightPower Client

Functions and features

- Supports the DeltaSNMP communications protocol
- Does multi hosts sleep/wakeup when combined with the InsightPower SNMP card
- Monitors software exclusively designed for InsightPower SNMP card
- Human-free automatic operating system close and archive
- Supports the Windows sleep function
- Mandatory setup response action
- Remote UPS on-the-spot management

Power off time settings

- Input power failure
- Battery capacity lower than setup value
- UPS battery voltage low
- Timed power off

Responsive actions

- Keep power events in sequence of date, time, and event description
- Voice alert
- Network broadcasting
- Email
- SMS
- Executes external programs and commands

Display

- On-the-spot digital monitoring
- Multiple display format including: dashboard, scale, indicator and graph
- Fast event and historical data inquiry
- Automatic historical data statistics

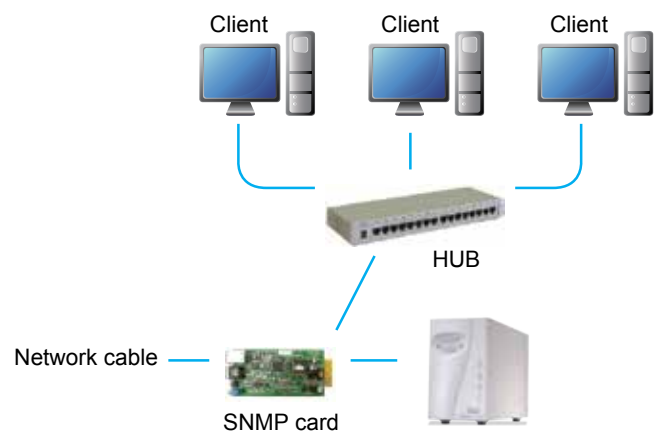

Scheduling

- Weekly or by given dates
- Power on and off time setups
- Fast battery test
- Deep battery test

Event tracking

- Keeps power events in sequence of date, time, and event description
- Keeps digital records for power quality analysis

Smart power off

- Press the smart power off button in web page of SNMP card to turn off any operating system installed with InsightPower Client and Shutdown Agent programs
- Smart power off shares the same settings with battery capacity low

UPSentry 2012

Functions and features

- Support RS232 and USB communication
- Provide web interface through HTTP and HTTPS
- Provide the batch configuration to deploy settings at a finger click
- Support SNMP Trap v1, v2c, v3
- Support SNMPv1, v3 server access for monitoring

Operating system support

- Windows XP-sp2, Vista, 7, 8
- Windows 2003, 2008, 2012
- Windows 2008 Server Core, Hyper-V 2008 R2
- Linux OpenSUSE 11.4
- Linux ubuntu 10.04
- Linux Fedora 3.1.9
- CentOS 5.8
- Citrix XenServer 6.0.0
- Linux KVM

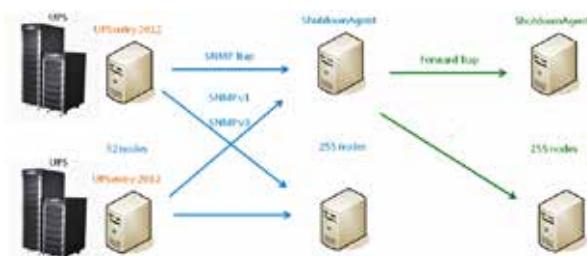

Scheduling

- Support scheduling shutdown, restart and battery test
- System power on/off
- 10 seconds test and deep discharge test

Web Interface

- Monitor UPS status through web interface
- System Summary: UPS identification, shutdown type, scheduling information and last five event log
- Battery: battery status, battery measurement, battery cabinet and replacement date
- In/Out/Bypass: Information of input measurement, bypass measurement and output measurement
- Identification: Information of identification and UPS rating

UPSentry 2012 status and configure shutdown parameters

- Work with ShutdownAgent 2012 to protect a huge number of hosts
- Provide console configuration for basic system parameters setup
- Support 32/64 bits software programs

Event Tracking

- Support 10,000 event log entries
- Display history values by a single date, month and year or a defined period of time
- Export data in csv. file format
- Clear the history data and event logs on the web interface



Shutdown Protection

- Input power fail
- Battery low
- Overload
- Bypass
- Schedule Shutdown

- Status Indication: Information of immediate UPS status indication
- Power Module: Information of power module bypass and power module ID1/2/3/4
- Shutdown Agent: Collect all of the ShutdownAgent 2012 which you assigned to work with UPSentry 2012 to protect a group of servers
- Display event log and history values

UPS Management

Shutdown Agent 2012

Functions and features

- Support SNMPv1, v3 trap
- Provide web interface through HTTP and HTTPS
- Provide the batch configuration to deploy settings at a finger click
- Forward SNMP trap to extend protecting up to 255 servers
- Support up to 32 input trap sources for redundant (logical OR) and parallel (logical AND) application
- Provide console configuration for basic system parameters setup
- Support Windows 32/64 bits setup programs

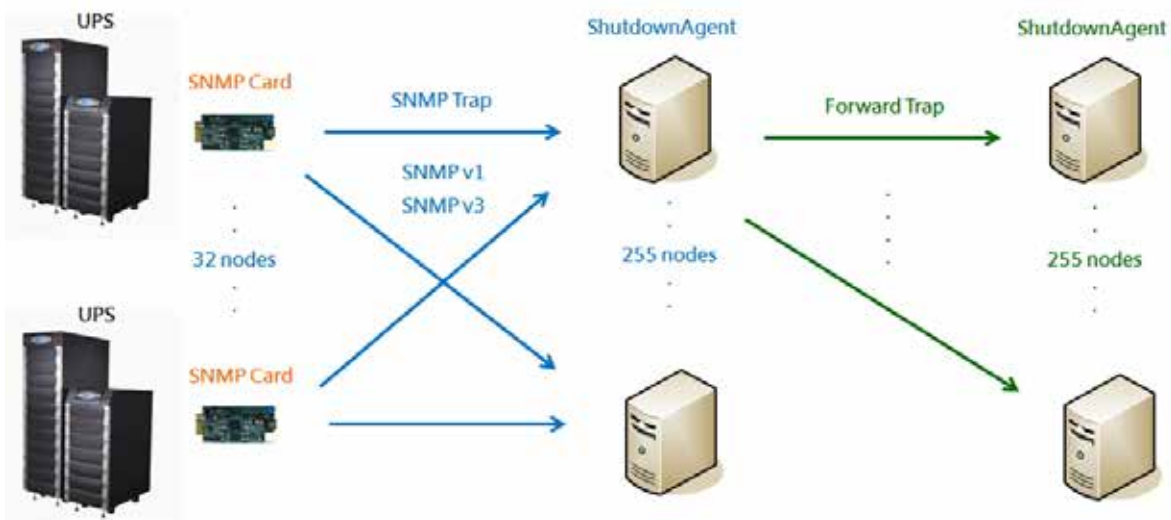

Operating system support

- Windows XP-sp2, Vista, 7, 8
- Windows 2003, 2008, 2012
- Windows 2008 Server Core, Hyper-V 2008 R2
- Linux OpenSUSE 11.4
- Linux ubuntu 10.04
- Linux Fedora 3.1.9
- CentOS 5.8
- VMWare ESXi 4.1, 5
- Citrix XenServer 6.0.0
- Linux KVM

Technical Specifications

SX Series, Single Phase

Model		SX600
Power Rating		600VA/360W
Input	Nominal Voltage	120 Vac
	Voltage Range	90 ~ 145 Vac
	Frequency	50/60Hz
Output	Voltage	120 Vac \pm 10%
	UPS + Surge Protection Output	3
	Outlet	Brazilian type x 3
Battery	Typical Backup Time	10min for one set of PC
	Recharge Time	8hrs recover to 90%
	Type	12V/7Ah, Lead-acid3
Efficiency	Normal Mode	>95%
Environment	Operating Temperature	0 ~ 40°C
	Relative Humidity	0 ~ 90% (non-condensing)
	Audible Noise (at one meter)	40 dBA
Physical	Dimensions (WxDxH)	207 x 228 x 82.5 mm
	Weight	2.7 kg

All specifications are subject to change without prior notice.



2007~ 2008 Forbes Asia's Fabulous 50



2009 Frost & Sullivan Green Excellence Award for Corporate Leadership



Delta's Manufacturing System is Certified by ISO 9001 and ISO 14001 Standards



IECQ Certificate of Hazardous Substance Process Management



VX Series, Single Phase

Model		VX-600
Power Rating		600VA/360W
Input	Nominal Voltage	230 Vac
	Voltage Range	140 ~ 300 Vac
	Line Conditioning	Buck: 255 ~ 300 Vac Boost 1: 170 ~ 195 Vac; Boost 2: 140 ~ 170 Vac
	Frequency	50 or 60 Hz (Auto-Detection)
Output	Voltage	230 Vac
	Voltage Regulation	± 10%
	Frequency	50 or 60 Hz (Auto-Detection)
	Outlets	India type 5A x 3, IEC C13 x 4
Battery	Type	12V/7Ah x 1, Lead-acid, Maintenance free
	Charging Time	4 ~ 6 hours recover to 90%
	Typical Backup Time	15min for one set of PC
Data Line Protection	Surge Protector	Network RJ45
Efficiency	Normal Mode	>95%
Environment	Operating Temperature	0 ~ 40°C
	Relative Humidity	0 ~ 90% (non-condensing)
Physical	Dimensions (WxDxH)	100 x 287 x 142 mm
	Weight	4.25 kg

All specifications are subject to change without prior notice.



2007~ 2008 Forbes Asia's Fabulous 50



2009 Frost & Sullivan Green Excellence Award for Corporate Leadership



Delta's Manufacturing System is Certified by ISO 9001 and ISO 14001 Standards



IECQ Certificate of Hazardous Substance Process Management

M Series, Single Phase

Model		M-1K	M-1.5K	M-2K	M-3K	
Power Rating		1 kVA / 0.9 kW	1.5 kVA / 1.35 kW	2 kVA / 1.8 kW	3 kVA / 2.7 kW	
Input	Nominal Voltage	220 / 230 / 240 Vac (Single Phase)				
	Voltage Range	-18% ~ +21%				
		220 Vac: 180-266 Vac				
		230 Vac: 188-278 Vac				
		240 Vac: 196-290 Vac				
	Frequency	50/60 Hz (± 5Hz) Auto selectable				
	Electrical Connection	IEC320 C14 x 1		IEC320 C20 x 1		
Output	Voltage	220 / 230 / 240 Vac (Single Phase)				
	Voltage Regulation	± 10%				
	Power Factor	0.9				
	Frequency	50/60 Hz (± 0.1Hz)				
	Overload Capability		111%~125%: Shutdown after 20 seconds			
			126% ~ 150%: Shutdown after 10 seconds			
			>150%: Shutdown immediately			
	Receptacle	IEC320 C13 x 2 x 4		IEC320 C13 x 2 x 4 IEC320 C19 x 1		
Battery	Nominal Voltage	36 Vdc	36 Vdc	72 Vdc	72 Vdc	
	Type	7 Ah	9 Ah	7 Ah	9 Ah	
	Typical Backup Time	≥ 4 minutes (full load)				
		≥ 10 minutes (half load)				
	Charging Capacity	6 hours to 90%				
Interface	Standard	RS232, USB, SMART slot , REPO				
Efficiency	Normal mode	97%		96%		
Environment	Relative Humidity	0 ~ 95% (non-condensing)				
	Temperature	0 ~ 40°C				
	Audible Noise (at one meter)	< 45 dBA	<45 dBA	<60 dBA	<60 dBA	
Physical	Display	LEDs				
	Dimensions (W* D* H)	440 x 429.4 x 88.5 mm		440 x 608 x 88.5 mm		
	Weight	18.5 kg	19.2 kg	33 kg	34.7 kg	
Conformance	Safety & EMC	CE, EN 62040-1, EMC EN62040-2 C1				
External Battery Pack (Optional and Only Applicable for 3kVA Model)	Dimensions (W* D* H)	N/A		440 x 429.4 x 8.5 mm		
	Weight	N/A		23.3 kg		
	Nominal Voltage	N/A		72 Vdc		
	Type	N/A		9 Ah		

All specifications are subject to change without prior notice.



2007~ 2008 Forbes Asia's Fabulous 50



2009 Frost & Sullivan Green Excellence Award for Corporate Leadership



Delta's Manufacturing System is Certified by ISO 9001 and ISO 14001 Standards



IECQ Certificate of Hazardous Substance Process Management



Technical Specifications

E Series, Single Phase

Model		E-1K	E-2K	E-3K
Power Rating		1kVA/700W	2kVA/1400W	3kVA/2100W
Input	Nominal Voltage	230 Vac (single phase)		
	Voltage Range	80 ~ 280 Vac *		
	Frequency	40 - 70 Hz		
	Power Factor	> 0.97		
	Electrical Connection	IEC320 C14	IEC320 C20	IEC320 C20
Output	Voltage	230 Vac (single phase)		
	Voltage Regulation	± 2%		
	Frequency	50 / 60 ± 0.05 Hz		
	Transient Response	< 8% (10 ~ 90% linear load)		
	Voltage Harmonic Distortion	≤ 3% (linear load)		
	Overload Capability	105 ~ 125%: 3 minutes; 125 ~ 150%: 30 seconds; > 150%: ≥0.5 second		
	Receptacle	India type 10A x 2		
Battery	Rating Voltage	36 Vdc	72 Vdc	72 Vdc
	Charge Current	Built-in: 4A (adjustable) Optional external charger: 4A		
	Electrical Connection	Terminal block		
Interface	Standard	RS232 x 1, Smart slot x 1		
Conformance	Safety & EMC	CISPR 22 Class A		
Other Features	AC-start & Battery-start	Yes		
Efficiency	AC-AC	> 87% (full load)		
Environment	Operating Temperature	0 ~ 40°C		
	Relative Humidity	0 ~ 90% (non-condensing)		
	Audible Noise (at one meter)	45 dBA	54 dBA	54 dBA
Physical	Dimensions (WxDxH)	140 x 362 x 267 mm		
	Weight	5 kg	7 kg	7 kg

* Lower range 80 ~ 175 Vac is acceptable under 50 ~ 100% loading condition.

All specifications are subject to change without prior notice. All specifications are subject to change without prior notice.



2007~ 2008 Forbes Asia's Fabulous 50



2009 Frost & Sullivan Green Excellence Award for Corporate Leadership



Delta's Manufacturing System is Certified by ISO 9001 and ISO 14001 Standards



IECQ Certificate of Hazardous Substance Process Management

Technical Specifications

N Series, Single Phase

Model		N-1K	N-2K	N-3K
Power Rating		1kVA/700W	2kVA/1400W	3kVA/2100W
Input	Nominal Voltage	230 Vac (single phase)		
	Voltage Range	80 ~ 280 Vac *		
	Frequency	40 - 70 Hz		
	Power Factor	> 0.97		
	Electrical Connection	Power cord (IEC320 C14)	Power cord (IEC320 C20)	Power cord (IEC320 C20)
Output	Voltage	230 Vac (single phase)		
	Voltage Regulation	± 2%		
	Frequency	50 / 60 ± 0.05 Hz		
	Wave Form	Pure sine wave		
	Transient Response	< 8%		
	Voltage Harmonic Distortion	< 3% (linear load)		
	Overload Capability	105 ~ 125%: 3 minutes; 125 ~ 150%: 30 seconds; > 150%: 1 second		
	Receptacle	IEC320 C13 x 4	IEC320 C13 x 8	IEC320 C13 x 8
Battery	Rating	12V/7Ah, 3 pcs	12V/7Ah, 6 pcs	12V/9Ah, 6 pcs
	Typical Backup Time	14 minutes (half load); 5 minutes (full load)		
	Recharge Time	≥ 8 hours to 80 ~ 90%		
Interface	Standard	RS232 x 1, MINI slot x 1	RS232 x 1, SMART slot x 1	RS232 x 1, SMART slot x 1
Conformance	Safety & EMC	EN62040-1; CISPR 22 Class A; EN62040-2		
Other Features	Data Line Protector	Optional (RJ11/RJ45, phone and network)		
	External Battery Pack	Optional for 1-3kVA		
Efficiency	AC-AC	> 87% (full load)		
Environment	Operating Temperature	0 ~ 40°C		
	Relative Humidity	5 ~ 95% (non-condensing)		
	Audible Noise (at one meter)	40 dBA	47 dBA	47 dBA
Physical	Dimensions (WxDxH)	140 x 366 x 242 mm	140 x 425 x 373 mm	140 x 425 x 373 mm
	Weight	14 kg	30.5 kg	30.5 kg

* Lower range 80 ~ 176 Vac is acceptable under 50 ~ 100% loading condition.
All specifications are subject to change without prior notice.



2007~ 2008 Forbes Asia's Fabulous 50



2009 Frost & Sullivan Green Excellence Award for Corporate Leadership



Delta's Manufacturing System is Certified by ISO 9001 and ISO 14001 Standards



IECQ Certificate of Hazardous Substance Process Management



Technical Specifications

N Series, Single Phase, 120V

Model		N-1K	N-2K	N-3K
Power Rating		1kVA/700W	2kVA/1400W	3kVA/2100W
Input	Nominal Voltage	110/120 Vac, single phase		
	Voltage Range	50 ~ 140 Vac (full load) *		
	Frequency	50 or 60 ± 5 Hz		
	Power Factor	> 0.97		
	Electrical Connection	Power cord (NEMA 5-15P)	Terminal	Terminal
Output	Voltage Regulation	± 2%		
	Frequency	50 / 60 ± 0.05 Hz		
	Wave Form	Pure sine wave		
	Voltage Harmonic Distortion	<4% (linear load)		
	Overload Capability	<105%: Continuous; 105~125%: 3 minutes 125~150%: 30 seconds; >150%: 0.5 second		
	Receptacle	NEMA 5-15Rx2x2	NEMA 5-15Rx2x2; Terminal	NEMA 5-15Rx2x2
Battery	Rating	12V/7Ah, 3 pcs	12V/7Ah, 6 pcs	12V/9Ah, 6 pcs
	Typical Backup Time	14 minutes (half load); 5 minutes (full load)		
	Recharge Time (Loading Level<75%)	≥ 8 hours to 80 ~ 90%		
Display	LED	Online, Bypass, On-battery, Overload, Battery low, Fault, Replace battery, Battery level, Loading level		
Interface	Standard	RS232 x 1, SNMP slot x 1		
Conformance	Safety	UL cUL		
	EMC	FCC CLASS B	FCC CLASS A	FCC CLASS A
Efficiency	AC-AC	> 87% (full load)		
Other Features	Battery Start	Yes		
	Data Line Protector	Optional (phone and network)		
	Extended Battery Cabinet	Optional		
Efficiency	AC-AC	> 87 % (full load)		
Environment	Temperature	0 ~ 40 °C		
	Relative Humidity	5 ~ 95 % (non-condensing)		
	Noise (at one meter)	40 dBA	47 dBA	52 dBA
Physical	Dimensions (WxDxH)	140 x 366 x 242 mm	140 x 425 x 373 mm	140 x 425 x 373 mm
	Weight	14 kg	29 kg	30.5 kg

* Lower range 50~80Vac is acceptable under 50~100% loading condition.
All specifications are subject to change without prior notice.



2007~ 2008 Forbes Asia's Fabulous 50



2009 Frost & Sullivan Green Excellence Award for Corporate Leadership



Delta's Manufacturing System is Certified by ISO 9001 and ISO 14001 Standards



IECQ Certificate of Hazardous Substance Process Management



R Series, Single Phase

Model		R-1K	R-2K	R-3K
Power Rating		1kVA/700W	2kVA/1400W	3kVA/2100W
Input	Nominal Voltage	220/230/240 Vac (single phase)		
	Voltage Range	80 ~ 280 Vac *		
	Frequency	40 - 70 Hz		
	Power Factor	> 0.97		
	Electrical Connection	Power cord (IEC320 C14)	Power cord (IEC320 C20)	Power cord (IEC320 C20)
Output	Voltage	230 Vac (single phase)		
	Voltage Regulation	± 2%		
	Frequency	50 / 60 ± 0.05 Hz		
	Wave Form	Pure sine wave		
	Transient Response	< 8%		
	Voltage Harmonic Distortion	< 3% (linear load)		
	Overload Capability	105 ~ 125%: 3 minutes; 125 ~ 150%: 30 seconds; > 150%: 1 second		
	Receptacle	IEC320 C13 x 4	IEC320 C13 x 8 IEC320 C19 x 1	IEC320 C13 x 8 IEC320 C19 x 1
Battery & Charger	Nominal Voltage	36 Vdc	72 Vdc	72 Vdc
	Charge Current	Built-in: max. 5A	Built-in: max. 4.5A	Built-in: max. 4.5A
		Additional charger (optional)		
Interface	Standard	RS232 x 1, SMART slot x 1		
Conformance	Safety & EMC	CE, EN62040-1 ; EN62040-2 ; CISPR 22 Class A		
Other Features	Rail Kit	Included		
	Tower Stand Kit	Optional		
	Data Line Protector	Optional		
Efficiency	AC-AC	> 87% (full load)		
Environment	Operating Temperature	0 ~ 40°C		
	Relative Humidity	5 ~ 95% (non-condensing)		
	Audible Noise (at one meter)	46 dBA	47 dBA	55 dBA
Physical	Dimensions (WxDxH)	440 x 450 x 89 mm	440 x 450 x 89 mm	440 x 450 x 89 mm
	Weight	6.7 kg	9.2 kg	9.2 kg

* Lower range 80 ~ 175 Vac is acceptable under 50 ~ 100% loading condition.
All specifications are subject to change without prior notice.



2007~ 2008 Forbes Asia's Fabulous 50



2009 Frost & Sullivan Green Excellence Award for Corporate Leadership



Delta's Manufacturing System is Certified by ISO 9001 and ISO 14001 Standards



IECQ Certificate of Hazardous Substance Process Management



GAIA Series, Single Phase

Model		GAIA-1K	GAIA-2K	GAIA-3K	
Power Rating		1kVA/800W	2kVA/1600W	3kVA/2100W	
Input	Nominal Voltage	200/208/220/230/240 Vac (single phase)*			
	Voltage Range	130 ~ 275 Vac**			
	Frequency	50/60 ± 5 Hz			
	Power Factor	> 0.97			
	Electrical Connection	Power cord (IEC320 C14)	Power cord (IEC320 C20)	Power cord (IEC320 C20)	
Output	Voltage	200/208/220/230(default)/240 Vac (single phase)*			
	Voltage Harmonic Distortion	< 3% (linear load); < 6% (computer load)			
	Voltage Regulation	± 2%			
	Frequency	50/60 ± 0.05 Hz			
	Wave Form	Pure sine wave			
	Overload Capability	105 ~ 125%: 3 minutes; 125 ~ 150%: 30 seconds; > 150%: 0.5 second			
	Receptacle	IEC320 C13 x 3 x 2	IEC320 C13 x 3 x 2 IEC320 C19 x 1	IEC320 C13 x 3 x 2 IEC320 C19 x 1	
Battery & Charger	Rating	12V/8.5Ah, 2 pcs	12V/8.5Ah, 4 pcs	12V/8.5Ah, 6 pcs	
	Charge Current	0.6 ~ 1.2A (default 0.8A)	0.6 ~ 1.2A (default 0.8A)	0.74 ~ 1.38A (default 1A)	
	Typical Backup Time	12 minutes (half load)	13 minutes (half load)	15 minutes (half load)	
		4 minutes (full load)	4 minutes (full load)	5 minutes (full load)	
Interface	Standard	RS232 x 1, USB x 1, SMART slot x 1			
Conformance	Safety	CE, EN62040-1			
	EMC	EN62040-2 Category C1	EN62040-2 Category C2	EN62040-2 Category C2	
Other Features	Data Line Protector	Built-in (RJ11/RJ45, phone and network)			
	REPO	RJ11 connector			
	Rail Kit	Optional			
	Tower Stand Kit	Included in package			
	External Battery Pack	Optional			
Efficiency	AC-AC	> 87% (full load)			
Environment	Operating Temperature	0 ~ 40°C			
	Relative Humidity	5 ~ 95% (non-condensing)			
	Audible Noise (at one meter)	45 dBA	50 dBA	60 dBA	
Physical	Dimensions (WxDxH)	UPS	440 x 335 x 89 mm	440 x 432 x 89 mm	440 x 610 x 89 mm
		Battery Pack	440 x 333 x 89 mm	440 x 430 x 89 mm	440 x 608 x 89 mm
	Weight	UPS	13 kg	21 kg	31 kg
		Battery Pack	16 kg	29 kg	43 kg

* For 200 Vac rating, UPS capacity will de-rate 10%.

** Lower range 130 ~ 160Vac is acceptable under 70 ~ 100 % loading condition.

All specifications are subject to change without prior notice.



2007~ 2008 Forbes Asia's Fabulous 50



2009 Frost & Sullivan Green Excellence Award for Corporate Leadership



Delta's Manufacturing System is Certified by ISO 9001 and ISO 14001 Standards



IECQ Certificate of Hazardous Substance Process Management



GAIA Series, Single Phase, 120V

Model		GAIA-1K	GAIA-2K	GAIA-3K	
Power Rating		1kVA/800W	2kVA/1600W	3kVA/2100W	
Input	Nominal Voltage	110/120 Vac (single phase)			
	Voltage Range	80 ~ 138 Vac (full load)*	90 ~ 138 Vac (full load)		
	Frequency	50 or 60 ± 5 Hz			
	Power Factor	> 0.97			
	Electrical Connection	Power cord	NEMA 5-20P	NEMA L5-30P	
		(NEMA 5-15P)	(Re-Wireable)		
Output	Voltage	120 Vac (single phase)			
	Voltage Harmonic Distortion	< 3% (linear load); < 6% (computer load)			
	Voltage Regulation	± 2%			
	Frequency	50 or 60(default) ± 0.05 Hz			
	Wave Form	Pure sine wave			
	Transient Response	<10% (10~90% Linear load)			
	Overload Capability	<105%: Continuous; 105~125%: 3 minutes			
		125~150%: 30 seconds; >150%: 0.5 second			
	Receptacle	NEMA 5-15Rx2x3	NEMA L5-20Rx1	NEMA L5-30Rx1	
			NEMA 5-15/20Rx6	NEMA 5-15/20Rx6	
Battery	Rating	12V/8.5Ah, 2pcs	12V/8.5Ah, 4pcs	12V/8.5Ah, 6pcs	
	Recharge Time	≤ 6 hours to 80%			
	Typical Backup Time	13 minutes (half load)	13.5 minutes (half load)	15 minutes (half load)	
		4 minutes (full load)	4 minutes (full load)	5 minutes (full load)	
Display	LED	Online, Bypass, On-battery, Overload, Battery low, Fault, Replace battery, Battery level, Loading level			
Interface	Standard	RS232 x 1, USB x 1, SNMP Slot x 1			
Other Features	Battery Start	Yes			
	Data Line Protector	Built-in (RJ11/RJ45, phone and network)			
	REPO	RJ11 connector			
	Rail Kit	Optional			
	Tower Stand Kit	Optional			
	Extended Battery Cabinet	Optional			
Efficiency	AC-AC	> 87% (full load)			
Environment	Temperature	0 ~ 40 °C			
	Relative Humidity	5 ~ 95% (non-condensing)			
	Noise (at one meter)	45 dBA	50 dBA	60 dBA	
Physical	Dimensions (WxDxH)	UPS	440 x 335 x 89 mm	440 x 432 x 89 mm	440 x 610 x 89 mm
		Battery Cabinet	440 x 333 x 89 mm	440 x 430 x 89 mm	440 x 608 x 89 mm
	Weight	UPS	13 kg	21 kg	31 kg
		Battery Cabinet	16 kg	29 kg	43 kg

* 65-80 (linearly de-rating between 70% ~ 100% loading)
All specifications are subject to change without prior notice.



2007~ 2008 Forbes Asia's Fabulous 50



2009 Frost & Sullivan Green Excellence Award for Corporate Leadership



Delta's Manufacturing System is Certified by ISO 9001 and ISO 14001 Standards



IECQ Certificate of Hazardous Substance Process Management

RT Series, Single Phase

Model		RT-5K	RT-6K	RT-10K	
Power Rating		5kVA/4.5kW	6VA/5.4kW	10kVA/9kW	
Input	Nominal Voltage	200/208/220/230/240 Vac (single phase)			
	Voltage Range	100 ~ 300 Vac*			
	Current Harmonic Distortion	< 5% (full load)			
	Power Factor	> 0.99 (full load)			
	Frequency	40 ~ 70 Hz			
	Electrical Connection	Terminal block			
Output	Voltage	200/208/220/230(default)/240 Vac (single phase)			
	Voltage Harmonic Distortion	< 2% (linear load)			
	Voltage Regulation	± 1% (static); ± 2% (typical)			
	Frequency	50/60 ± 0.05 Hz			
	Overload Capability	106 ~ 110%: 10 minutes; 111 ~ 125%: 5 minutes; 126 ~ 150%: 30 seconds			
	Electrical Connection	Terminal block			
	Crest Factor	3:1			
Battery & Charger	Nominal Voltage	192 Vdc	192 Vdc	240 Vdc	
	Charge Current	Built-in: maximum 4A (adjustable); Additional charger board (optional): maximum 4A (internal installation)			
Interface	Standard	RS 232 x1, SMART slot x 1; MINI slot x 1, Parallel port x1			
Conformance	Safety & EMC	CE, EN62040-1; EN62040-2; CISPR 22 Class A			
Other Features	Parallel Redundancy	1+1			
	Remote Control	REPO; Remote On/Off			
	Common Battery Installation	Yes			
Efficiency	AC-AC	92% (full load)			
	ECO Mode	96% (full load)			
Environment	Operating Temperature	0 ~ 40°C			
	Relative Humidity	0 ~ 95% (non-condensing)			
	Audible Noise (at one meter)	< 56 dBA	< 58 dBA	< 58 dBA	
Physical	Dimensions (WxDxH)	UPS	440 x 671 x 89 mm	440 x 671 x 89 mm	440 x 623 x 131 mm
		Battery Pack	440 x 638 x 89 mm	440 x 638 x 89 mm	440 x 595 x 131 mm
	Weight	UPS	15kg	15.5 kg	21.3 kg
		Battery Pack	36 kg	36 kg	66 kg

* For 5 and 6 kVA models, lower range 100 ~ 155 Vac is acceptable under 50 ~ 100% loading condition.

For 10 kVA model, lower range 100 ~ 180 Vac is acceptable under 50 ~ 100% loading condition.

All specifications are subject to change without prior notice.



2007~ 2008 Forbes Asia's Fabulous 50



2009 Frost & Sullivan Green Excellence Award for Corporate Leadership



Delta's Manufacturing System is Certified by ISO 9001 and ISO 14001 Standards



IECQ Certificate of Hazardous Substance Process Management



N Series, Single Phase

Model		N-6K	N-12k
Rated Capacity		6KVA / 4.2KW	12KVA / 8.4KW
Input	Rated voltage	220V / 230V / 240V	
	Voltage Range	120 ~ 280Vac (≤70% Rated Load)	
	Frequency Range	60Hz	
	Input Power Factor	>0.99	
Output	Voltage Range	120V, 220V	
	Voltage Stability Margin	±2%	
	Frequency Range	60Hz	
	Frequency Stability Margin	±0.05Hz	
	Wave	Sine wave	
	Overload capacity	102%~125% for 1 minute 125%~150% for 30 seconds > 150% immediately	
	Overall Efficiency (normal input voltage)	AC-AC : >88%	
		ECO Mode : >94%	
Battery	Type	Lead-acid, Maintenance-free Battery	
	Standby Duration(Full Load)	≥7 minutes	≥3 minutes
Communication Interfaces	Standard	RS232 x 1, SNMP slot x1, Dry contact port x 1, REPO	
Environment	Noise (1m away)	<53dB	<65dB
	Temperature	0~40°C	
	Humidity	5%~95% (without dew)	
Miscellaneous	Regulatory Compliance	EN50091-1-1 / CE	
	Electromagnetic Compatibility	CNS 13438 Class A/ EN62040-2 Class A	
	EMC	IEC61000-2-2 / IEC61000-4-2 Level 3 / IEC61000-4-3 Level 3 / IEC61000-4-4 Level 4 / IEC61000-4-5 Level 4	
	Battery Activation	Yes	
Mechanical	External Battery	Yes (Optional)	
	Dimensions (WxDxH) (mm)	280 x 581 x 783.8	
	Weight (Kg)	133	165

All specifications are subject to change without prior notice.



2007~ 2008 Forbes Asia's Fabulous 50



2009 Frost & Sullivan Green Excellence Award for Corporate Leadership



Delta's Manufacturing System is Certified by ISO 9001 and ISO 14001 Standards



IECQ Certificate of Hazardous Substance Process Management



EH Series, Three Phase In - Single Phase Out

Model		EH-10K	EH-15K	EH-20K
Power Rating - kVA		10	15	20
Power Rating - kW		8	12	16
Input	Nominal Voltage	220/380 Vac, 230/400 Vac, 240/415 Vac (3 phase , 4 - wire+G)		
	Voltage Range	208~304 Vac (50%~100% load) / 305~477 Vac (100% load)		
	Power Factor	> 0.95 (full load)		
	Frequency	50/ 60 Hz		
Output	Voltage	220/230/240 Vac (single phase)		
	Voltage Harmonic Distortion	< 3% (linear load)		
	Voltage Regulation	± 2%		
	Frequency	50/60 ± 0.1 Hz		
	Overload Capability	≤105 %: continuous; 106%~110%: 10 minutes; 111%~125%: 1 minute; 126%~150%: 30 seconds		
Battery & Charger	Battery Voltage	240 Vdc		
	Charge Current	Built-in: 4A, Additional charger board (optional): 4A		
	Charge Voltage	Float charge 272 ± 2 Vdc, Boost charge 280 Vdc		
Communication Interfaces		SMART slot x 1, MINI slot x 1, Parallel Port x 2, RS232 Port x 1, REPO Port x 1, Charger Detection Port x 1		
Conformance	Safety & EMC	CE, IEC62040-1, IEC62040-2		
Other Features	Emergency Power Off	Local and remote		
	Maintenance Bypass Switch	Built-in		
Efficiency	Online Mode	91%		
	ECO Mode	96%		
Environment	Operating Temperature	0 ~ 40°C		
	Relative Humidity	5 ~ 95% (non-condensing)		
	Audible Noise	< 55 dBA	< 60 dBA	< 60 dBA
Physical	Dimensions (W x D x H)	200 x 490 x 490 mm	250 x 610 x 650 mm	
	Weight	26 Kg	45 Kg	

All specifications are subject to change without prior notice.



2007~ 2008 Forbes Asia's Fabulous 50



2009 Frost & Sullivan Green Excellence Award for Corporate Leadership



Delta's Manufacturing System is Certified by ISO 9001 and ISO 14001 Standards



IECQ Certificate of Hazardous Substance Process Management



HPH Series, Three Phase

Model		HPH-20K HPH-20K-BN / B	HPH-30K HPH-30K-BN / B	HPH-40K HPH-40K-BN / B
Power Rating		20KW	30KW	40KW
Input	Nominal Voltage Voltage Range Frequency Power Factor Current Harmonic Distortion	220/380 Vac; 230/400 Vac; 240/415 Vac - 40% ~ 20% (242 ~ 477/140 ~ 276 Vac) * 50/60Hz +/- 10Hz > 0.99 (full load) < 3%		
Output	Voltage Voltage Regulation Voltage Harmonic Distortion Overload Capability Frequency	220/380 Vac; 230/400 Vac; 240/415 Vac ±1 % < 1.5 % (linear load) ≤105 %: continuous; 106% ~ ≤125%: 10 minutes; 126% ~ ≤150%: 1 minute; >150%: 1 second 50/60Hz +/- 0.05Hz		
Battery	Type Battery Voltage Charge Current Charge Current (BN / B) Typical Backup Time ** Charge Voltage	SMF/VRLA ± 240 Vdc 5A 5A, 9A (option) 15 min 10 min 9.5 min Float charge ±272 V ±2Vdc, Boost Charge ±280V ±2Vdc		
Communication Interfaces		SMART Slot x 1, MINI Slot x 1, Parallel Port x 2, RS232 Port x 1, REPO Port x 1, Charger Detection Port x 1, Input Dry Contact x 2, Output Dry Contact x 6		
Conformance	Safety & EMC	CE, IEC62040-1, IEC602040-2		
Other Features	Emergency Power Off Maintenance Bypass Switch	Yes (local and remote) Yes		
Efficiency	Online Mode ECO Mode	Up to 96% Up to 99%		
Environment	Operating Temperature Relative Humidity Audible Noise Protection Level	0 ~ 40 °C 5% ~ 95 % (no condensing) < 55 dBA < 60 dBA IP21		
Physical	Dimensions (W x D x H) Weight	380 x 800 x 800 mm 66.5 Kg	86.2 Kg	86.5 Kg
Physical (BN / B)	Dimensions (W x D x H) Weight (with batt.) Weight (without batt.)	490 x 830 x 1400 mm 365 Kg 131 Kg	385 Kg 162 Kg	

HPH-B: UPS integrated battery model has batteries inside

HPH-BN: UPS integrated battery model has no batteries inside

* When input voltage is 242 ~ 324/140 ~ 187 Vac, the sustainable loading is from 70% to 100% of the UPS capacity.

** At 70% load with internal battery strings.

All specifications are subject to change without prior notice.



2007~ 2008 Forbes Asia's Fabulous 50



2009 Frost & Sullivan Green Excellence Award for Corporate Leadership



Delta's Manufacturing System is Certified by ISO 9001 and ISO 14001 Standards



IECQ Certificate of Hazardous Substance Process Management



NT Series, Three Phase

Model		NT-20K	30K	40K	50K	60K	80K	100K	120K	160K	200K	260K	320K	400K	500K		
Power Rating - kVA		20	30	40	50	60	80	100	120	160	200	260	320	400	500		
Power Rating - kW		16	24	32	40	48	64	80	96	128	160	208	256	320	400		
Input	Nominal Voltage	208/120, 380/220, 400/230, 415/240, 480/277 Vac (3 phase, 4-wire + G)															
	Voltage Range	± 20%															
	Current Harmonic Distortion	< 3% (with optional filter)															
	Frequency	50/60 Hz ± 5 Hz															
Output	Voltage	208/120, 380/220, 400/230, 415/240, 480/277 Vac (3 phase, 4-wire + G) 220, 230, 240 Vac (1 phase, 2-wire + G) *															
	Voltage Harmonic Distortion	≤ 3% (linear load)															
	Voltage Regulation	± 1% (static)															
	Frequency	50/60 Hz															
	Frequency Regulation	± 0.01% (internal oscillator); ± 1% (synchronized)															
	Overload Capability	≤ 110%: 60 minutes; 110 ~ 125%: 10 minutes; 126 ~ 150%: 1 minute															
Interface	Standard	RS232 x 1, RS485 x 2, SMART slot x 1, Status dry contact output x 6															
Other Features	Parallel Redundancy	Up to 8 units															
	Emergency Power Off	Local and remote															
	SRAM Event Log	500 records															
	Input Harmonic Improvement	Optional harmonic filter and 12-pulse rectifier															
Efficiency	AC-AC	%	90	91	91.5	92	92.5	93									
	ECO Mode	%	>97	>97.5													
Environment	Operating Temperature	0 ~ 40°C															
	Relative Humidity	0 ~ 90% (non-condensing)															
	Audible Noise (at 1.5 meters)	dBA	≤ 60			≤ 65			≤ 68			≤ 72			≤ 77		
Physical	Dimensions **	Width	mm	600				800			1200			1600			1900
		Depth	mm	800				830			830			995			995
		Height	mm	1400				1700			1700			1950			1950
	Weight ***	kg	365	365	425	460	506	525	700	745	1050	1085	1680	1720	1920	2410	

* Single phase output voltage: 220/230/240 is only for 20 ~ 40 kVA models.

** Standard rating is 380/220 Vac with 6 pulse rectifier. For models: (1) different rating (2) with 12 pulse rectifier or filter, dimensions and weight would be different from standard models. Please contact your local supplier for more information.

*** 500 kVA model is assembled into two cabinets: Inverter (width=1100 mm, 1760 kg) and Rectifier (width=800 mm, 650 kg).

All specifications are subject to change without prior notice.



2007~ 2008 Forbes Asia's Fabulous 50



2009 Frost & Sullivan Green Excellence Award for Corporate Leadership



Delta's Manufacturing System is Certified by ISO 9001 and ISO 14001 Standards



IECQ Certificate of Hazardous Substance Process Management



DPS Series, Three Phase

Model		DPS-60K	DPS-80K	DPS-100K	DPS-120K	DPS-160K	DPS-200K	DPS-300K	DPS-400K
Power Rating - kVA		60	80	100	120	160	200	300	400
Input	Nominal Voltage	380/220V, 400/230V (3 phase, 4-wire +G)							
	Voltage Range	208~477 Vac*				242~477 Vac**			
	Current Harmonic Distortion	< 3%***							
	Power Factor	> 0.99							
	Frequency	50/60 ± 5 Hz							
Output	Voltage	380/220V, 400/230V (3 phase, 4-wire +G)							
	Output Power Factor	0.9							
	Voltage Harmonic Distortion	≤ 3 % (linear load)				≤ 1.5 % (linear load)			
	Voltage Regulation	±1% (static)							
	Frequency	50/60 ± 0.05 Hz							
	Overload Capacity	≤ 125%: 10 minutes ; ≤ 150%: 1 minute							
Display	Mimic LCD supports multi-language and LED indicators								
Interface	Standard	RS232 x 1, SMART slot x 2, Dry contact output x 6, Input dry contact x2, Battery cabinet temperature x 4, REPO x1, Parallel port x 2				RS232 x 1, Smart slot x 2, Dry contact output x 6, Dry contact input x 2, Battery cabinet temperature sensor x 4, Battery status detection, Parallel port x 2, REPO x 1			
	Management Peripherals	SNMP card, Modbus card, Relay I/O control card, EnviroProbe, SNMP hub							
Display	Mimic LCD supports multi-language and LED indicators								
Conformance	Safety & EMC	EN 62040-1; CE; IEC 62040-2							
Other Features	Parallel Redundancy and Expansion	Yes (up to 4 units)				Yes (up to 8 units)			
	Emergency Power Off	Yes (local and remote)							
	Event Log	500 records				3000 records			
Efficiency	AC-AC	Up to 96%							
	ECO Mode	Up to 99%							
Environment	Operating Temperature	0 ~ 40°C							
	Relative Humidity	0~95% (non-condensing)							
	Audible Noise (at one meter)	< 64 dBA	< 64 dBA	< 67 dBA	< 67 dBA	< 70 dBA	< 70 dBA	< 73 dBA	< 73 dBA
Physical	Dimensions (WxDxH)	520 x 975 x 1695 mm				850 x 865 x 1950 mm		1600 x 865 x 1950 mm	
	Weight	300 kg	330 kg	360 kg	390 kg	697 kg	1335 kg		

* When input voltage is 208~300 Vac, the sustainable loading is from 70% to 100% of the UPS capacity.

** When input voltage is 242~324 Vac, the sustainable loading is from 70% to 100% of the UPS capacity.

*** When input harmonic distortion is less than 1%.

All specifications are subject to change without prior notice.



2007~ 2008 Forbes Asia's Fabulous 50



2009 Frost & Sullivan Green Excellence Award for Corporate Leadership



Delta's Manufacturing System is Certified by ISO 9001 and ISO 14001 Standards



IECQ Certificate of Hazardous Substance Process Management



Precisely Right.

Delta Ultron DPS 160~400kVA Efficiency is Tested by TÜV

NH Plus Series, Three Phase

Model		NHP-20K	NHP-40K	NHP-60K	NHP-80K	NHP-100K	NHP-120K
Power Rating - kVA		20	40	60	80	100	120
Power Rating - kW*		18	36	54	72	90	108
Input	Nominal Voltage	380/220, 400/230, 415/240 Vac (3 phase, 4-wire + G)					
	Voltage Range	208 ~ 477 Vac (line-line)/120 ~ 276 Vac (line-neutral) **					
	Current Harmonic Distortion	< 3% (full load)					
	Power Factor	> 0.99					
	Frequency	50/60 ± 5 Hz					
Output	Voltage	380/220, 400/230, 415/240 Vac (3 phase, 4-wire + G)					
	Voltage Harmonic Distortion	< 3% (linear load)					
	Voltage Regulation	± 1% (static)					
	Frequency	50/60 ± 0.05 Hz					
	Overload Capability	≤ 125%: 10 minutes; ≤ 150%: 1 minute					
Interface	Standard	RS232 x 1, SMART slot x 2, Dry contact output x 6, Dry contact input x 2, Battery cabinet temperature x 4, Battery cabinet status detection x 1, Parallel port x 1, REPO x 1					
	Management Peripherals	SNMP card, Modbus card, Relay I/O control card, EnviroProbe, Battery cabinet temperature sensor, Battery cabinet status cable					
Conformance	Safety & EMC	CE, EN62040-1, EN62040-2					
Other Features	Parallel Redundancy and Expansion	Module and system redundancy; Maximum 4 units in parallel up to 480 kVA					
	Emergency Power Off	Local and remote					
	SRAM Event Log	500 records					
Efficiency	AC-AC	94%					
	ECO Mode	97%					
Environment	Operating Temperature	0 ~ 40°C					
	Relative Humidity	0 ~ 90% (non-condensing)					
	Audible Noise (at one meter)	< 64 dBA	< 64 dBA	< 64 dBA	< 64 dBA	< 67 dBA	< 67 dBA
Physical	Dimensions UPS	520 x 855 x 1165 mm				520 x 975 x 1695 mm	
	(WxDxH) Battery Pack	520 x 855 x 1165 mm (28 Ah x 40 pcs)				520 x 975 x 1695 mm (40 Ah x 40 pcs)	
	Weight	112.5 kg	128 kg	230 kg	260 kg	350 kg	380 kg

* Subject to reconfiguration of the UPS; Delta provides the configuration service.

** When input voltage is 208~300/120~173 Vac, the sustainable loading is from 70% to 100% of the UPS capacity.

All specifications are subject to change without prior notice.



2007~ 2008 Forbes Asia's Fabulous 50



2009 Frost & Sullivan Green Excellence Award for Corporate Leadership



Delta's Manufacturing System is Certified by ISO 9001 and ISO 14001 Standards



IECQ Certificate of Hazardous Substance Process Management



NHV Plus Series, Three Phase, 120V

Model		NHVP-40K	NHVP-60K	NHVP-80K	NHVP-100K	NHVP-120K
Capacity	kVA	40	60	80	100	120
	kW*	36	54	72	90	108
Input	Nominal Voltage	120/208Vac, 127/220Vac (3 phase, 4-wire + G)				
	Voltage Range	-25% ~ +20%				
	Current Harmonic Distortion**	<3%				
	Input Power Factor	>0.99				
	Frequency	50/60 Hz				
	Input Frequency Range	45~65 Hz				
Output	Voltage	120/208Vac, 127/220Vac (3 phase, 4-wire + G)				
	Voltage Regulation	±1%				
	Frequency	50 or 60 Hz				
	Frequency Regulation	± 0.05 Hz				
	Voltage Harmonic Distortion	<3%				
	Overload	≤125%: 10mins; ≤150%: 1min				
Display	LED	UPS status: Normal, Battery, Bypass and Fault				
	LCD	Input/Output, Bypass, Inverter, Frequency, Loading and battery voltage ,Current, UPS Abnormal message and Intelligent selg diagnosis				
Interface	Standard	RS232 x1, Smart card slot x2, Input dry contact x2, Output dry contact x 6				
	Optional	SNMP IPv6 card, ModBus card, Relay I/O control card				
Other Features	Parallel Redundancy	Yes, up to 2 units				
	EPO	Standard (Local & Remote)				
	SRAM Event Log	Yes (500 records)				
	Parameter Configuration	Yes				
	Hot Standby Installation	Feasible				
	Battery Start	Standard				
	Battery Temperature Compensation	Optional				
Efficiency	AC-AC	94%				
	ECO Mode	97%				
Environment	Temperature	0~40°C				
	Humidity	0 ~ 90 % (non-condensing)				
	Noise	<70 dBA				
Physical	Dimensions (WxDxH)	520 x 910 x 1696 mm			1080 x 970 x 1696 mm	1080 x 970 x 1696 mm
	Weight	488 kg	570 kg	665 kg	959 kg	1064.5 kg

* Under operating temperature <25°C

** When Input vTHD is < 1%



2007- 2008 Forbes Asia's Fabulous 50



2009 Frost & Sullivan Green Excellence Award for Corporate Leadership



Delta's Manufacturing System is Certified by ISO 9001 and ISO 14001 Standards



IECQ Certificate of Hazardous Substance Process Management



Technical Specifications

DPH Series, Three Phase

Model		DPH-25K	DPH-50K	DPH-75K	DPH-100K	DPH-125K	DPH-150K	DPH-175K	DPH-200K
Power Rating - kVA		25	50	75	100	125	150	175	200
Power Rating - kW		25	50	75	100	125	150	175	200
Input	Nominal Voltage	380/220V, 400/230V (3 phase, 4-wire +G)							
	Voltage Range	176~276 / 305~477 Vac*							
	Current Harmonic Distortion	< 3%**							
	Power Factor	> 0.99							
	Frequency	50/60 ± 5 Hz							
Output	Voltage	380/220V, 400/230V, 415/240V (3 phase, 4-wire +G)							
	Output Power Factor	1 (kVA = kW)							
	Voltage Harmonic Distortion	≤ 2% (linear load)							
	Voltage Regulation	±1% (static)							
	Frequency	50/60 Hz							
	Frequency Regulation	±0.05 Hz							
	Overload Capacity	≤ 125%: 10 minutes; ≤ 150%: 1 minute							
Interface	Standard	Parallel port x 2, SMART slot x 2, Dry contact output x 6, Dry contact input x 6, Battery dry contact x 6							
	Optional	EnviroProbe, Battery cabinet temperature sensor, Battery cabinet status cable, SNMP card x 2, SNMP card IPv6, ModBus card, Relay I/O control card							
Conformance	Safety & EMC	CE, EN62040-1, EN62040-2							
Other Features	Parallel Redundancy and Expansion	Module and system redundancy; Maximum 4 units up to 800 kW							
	Emergency Power Off	Local and remote							
	Battery start	Yes							
	Event Log	3000 records							
	External Battery Cabinet	Optional							
Efficiency	AC-AC	96%							
	ECO Mode	99%							
Environment	Operating Temperature	0 ~ 40 °C							
	Relative Humidity	0 ~ 90% (non-condensing)							
	Audible Noise (at one meter)	<59 dBA	<59 dBA	<60 dBA	<60 dBA	<61 dBA	<61 dBA	<62 dBA	<62 dBA
Physical	Dimensions (WxDxH)	600 x 1090 x 2000 mm							
	Weight	382 kg	414 kg	446 kg	478 kg	510 kg	542 kg	574 kg	606 kg

* When input voltage is 140/242~176/305 Vac, the sustainable loading is from 60% to 100% of the UPS capacity.

** When input harmonic distortion is less than 1%.

All specifications are subject to change without prior notice.



2007~2008 Forbes Asia's Fabulous 50



2009 Frost & Sullivan Green Excellence Award for Corporate Leadership



Delta's Manufacturing System is Certified by ISO 9001 and ISO 14001 Standards



IECQ Certificate of Hazardous Substance Process Management



UPS Q&A

Power issues

Q What are the power issues?

A

Based on a survey made by Contingency Planning, poor power quality is the key factor in computer data loss. In addition to black outs, other power quality problems are: voltage sag, spikes, voltage surges, noise, and voltage too low (high). These are the events that lead to damage and reduce the life of computer components as well as cause data loss and damage.

Q How can these power issues be solved?

A

There are quite a few methods for dealing with power problems. The three most commonly used are: a surge absorber, a regulator or a UPS.

Power issue	Solution		
	Surge absorber	Regulator	Online UPS
Black out	X	X	✓
Sag	X	▲	✓
Surge	▲	▲	✓
Noise	X	X	✓
Spike	▲	▲	✓
Frequency drift	X	X	✓

X : Cannot deal with

▲ : Can partly deal with

✓ : Can totally deal with

Q What is a voltage sag? What is its impact on computer equipment?

A

Voltage sag is the most common power problem we may encounter and it is responsible for 87% of all power issues. A voltage sag is a short period of voltage drop caused by some outside problem. This may result in operation failure of computer peripherals, such as the keyboard in minor cases, or it might lead to data loss and file damage in its more serious form. Voltage sag may also damage computer components and reduce their working lives.

UPS Q&A

Q What is a spike? What is its impact on computer equipment?

A

A spike is a great increase in voltage of very short duration. In most cases it is generated by lightning in nearby regions. It may damage computer hardware or precision equipment and result in data loss.

Q What is a voltage surge? What is its impact on computer equipment?

A

When powering off high-current equipment or a group of high load equipment connected to a single power source, an inertial voltage surge may be generated during power transmission. Most computers or precision equipment feature a certain range of operational voltage that accommodates such a situation. However, if the voltage surge is greater than the tolerance settings, some equipment or components may be damaged and this can lead to equipment failure and a reduced working life.

Q What is noise? What is its impact on computer equipment?

A

A score of factors are responsible for noise, including lightning, the powering on or off of nearby equipment, generators, and even wireless communications. Noise may cause precision equipment or computers to fail or result in program runtime errors.



Types of UPS

Q Why is a UPS needed?

A

Unsteady power quality can affect the normal operation of a computer. A UPS not only provides immediate power in case of blackout, but also provides stable and clean power under normal conditions. It improves the incoming power by regulation and filtration and also suppresses spikes caused by lightning. A UPS, is like a personal insurance policy and protects your computer equipment against power risks.

Q What kinds of UPS are there?

A

There are three types of UPS: Off-Line On-Line and Line-Interactive.

Q What is an Off-Line UPS?

A

Please refer to the off-line system diagram.

Equipment is powered by the grid directly through a bypass line. In the event of a power failure it is powered by AC current generated by an inverter run by a battery in the UPS.

Features

1. When commercial power is normal, the UPS does nothing and the load is handled directly by the grid. This type does not improve grid power with respect to noise and surge suppression (filter typically used has low capacity).
2. Provides the least protection as a certain conversion time is needed.
3. Simple in structure, compact in size, light in weight, easy to control and not very expensive.

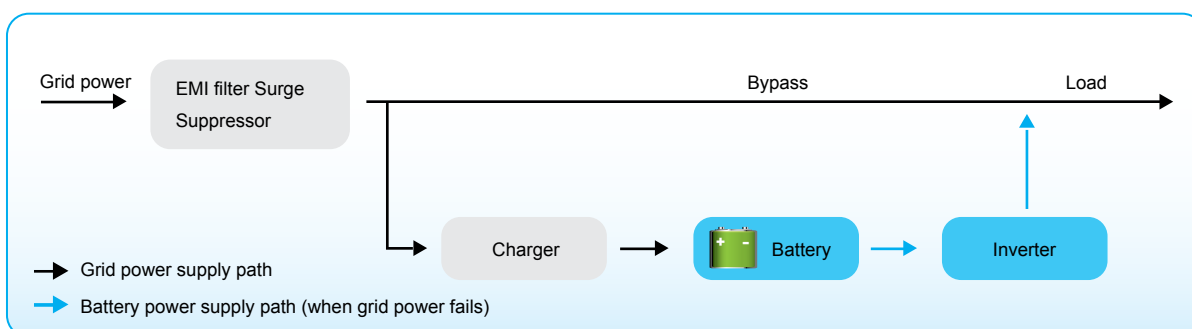

UPS Q&A

Q What is an On-Line UPS?

A

Please refer to the on-line UPS diagram.

The on-line UPS supplies power to the load by output from the inverter and uses the bypass path only in a case where the UPS itself fails, is overloaded, or overheats.

Features

1. Output power to the load is of the best quality as it is processed by the UPS.
2. No conversion time is required.
3. Complex in structure and expensive.
4. Gives the highest protection and has excellent noise filtering and surge suppression capacity.

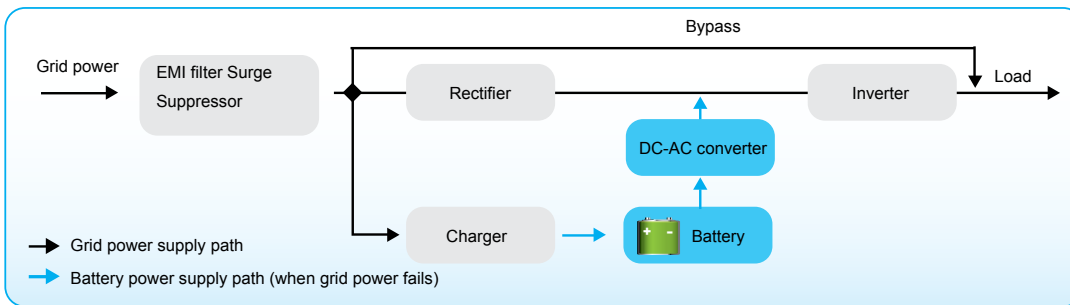

Q What is a Line-Interactive UPS?

A

Please refer to the line-interactive UPS diagram.

The line-interactive UPS supplies power to the load through the bypass path with output from the inverter when grid power is normal. The inverter acts as a charger at this time. In the event of a black out, the inverter converts DC current from the battery to AC for output to the load.

Features

1. The bi-directional conversion design reduces the time required for charging the UPS battery.
2. Requires a certain conversion time.
3. The complex control mechanism makes it more expensive.
4. Has protection capacity between that of the on-line and off-line UPSs. It is less effective in noise filtering and surge suppression.

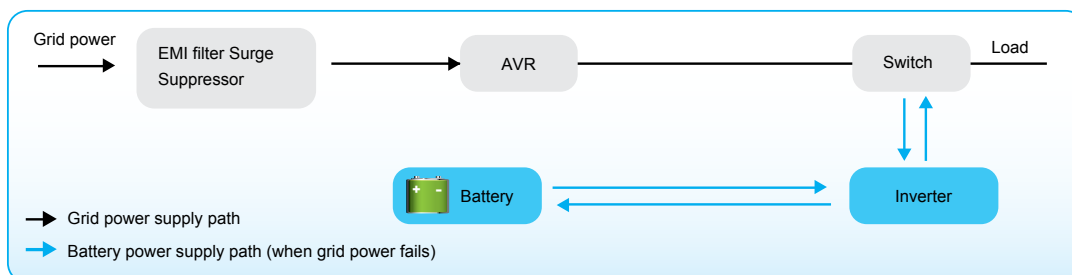

Common battery problems

Q What kinds of batteries are used in a UPS?

A

Most commercially available UPS use VRLA batteries that are water-and maintenance-free. The energy is generated by chemical reactions in a paste-like electrolyte. For most consumers, these batteries are not only easy to use and maintain but also simple to replace when necessary.

Q What is the life cycle of a battery?

A

The power provided by a UPS comes from the discharge of its batteries. Batteries age not only with use and external factors but also from the internal chemical reactions. Batteries will still age even when not in use.

Q How should a battery be maintained?

A

Regular charging and discharging is very important for battery maintenance. You can regularly execute this function if your UPS has the battery test feature. Otherwise, you can simply unplug the input to your UPS to simulate a grid power black-out and check the time the battery takes to discharge. Please replace your batteries with new ones when the discharge time becomes less than that given in the specification. This will ensure that there is enough discharge time for the system to save files and be shut down in case of grid power failure.

Q How is the capacity of a UPS determined?

A

Most commercially available UPS now express their capacity as VA. V stands for voltage and A for current in amps. In short, VA equals the power and capacity of a UPS. For example, a UPS of 500VA capacity with an output of 110V will provide a maximum current of 4.55A and more than this will lead to overload. The unit of power can be expressed in Watts. While the Watt indicates active power, VA indicates apparent power and Watt equals VA multiplied by the power factor ($VA \times pf = \text{Watt}$). There is no common criterion for power factor (pf). Generally a value of between 0.6 and 0.9 is acceptable while a value of 0.5 may represent poor design. Pay attention to this value when purchasing a UPS. A high power factor implies better utilization and more economical use of power.

Q Where can we have our batteries replaced?

A

Please contact the service center or your UPS dealer when you need to replace your batteries.

Q Where can an appropriate UPS be bought?

A

1. Learn about the applicability of each type of UPS.
2. Appraise your needs for power quality.
3. Learn the required UPS capacity and appraise the total capacity required for future expansion.
4. Select a market proven brand and supplier.
5. Purchase an appropriate UPS that is suitable for your requirements.

Q Is a UPS really needed in places with very few black-outs?

A

Statistics indicate that black-outs are a minor power issue. Other, not so obvious power issues, like over-voltage, under-voltage and surges are the major ones. In addition to providing extended power for long stretches, a UPS is designed to provide customers with critical total power protection against voltage drift, surges, high frequency interference, and any other kind of power failure and drift.

Q How long should the UPS provide power?

A

The single most important function of a UPS is to provide adequate backup power for the equipment load. The time a UPS should provide power should be long enough for users to finish running procedures in case of power failure. In general, 5 to 10 minutes should be enough. If longer than this is required, you can purchase a UPS that includes an external battery cabinet(s) that will increase the UPS backup time.

Europe

Czech Republic

Delta Energy Systems
(Czech Republic), spol.s r.o.
Perucka 2482/7
120 00 Praha 2
Czech Republic
T +420 272 019 330
F +420 271 751 799

Finland

Delta Energy Systems (Finland) Oy
P.O. Box 63, Juvan teollisuuskatu 15, FIN-
02921 Espoo, Finland
T +358 9 84966 0
F +358 9 84966 100

France

Delta Energy Systems (France) S.A.
ZA Bois Chaland2 - 15 rue des Pyrénées -
Lisses 91090, France
T +33 1 69 77 82 60
F +33 1 64 97 05 77

Germany

Delta Energy Systems (Switzerland) AG
Coester Weg 45, 59494 Soest, Germany
T +49 2921 987 337
F +49 2921 987 396

The Netherlands

Deltronics Netherlands BV
Zandsteen 15, 2132MZ Hoofddorp,
The Netherlands
T +39 06 699 41 209
F +39 06 699 41 209

Poland

Delta Energy Systems (Poland) Sp. z.o.o.
23 Poleczki Str., 02-822 Warszawa,
Poland
T +48 22 335 26 00
F +48 22 335 26 01

Russia

Delta Energy Systems LLC
Vereyskaya Plaza II, office 401, Vereyskaya
str.17, 121357 Moscow, Russia
T +48 22 335 26 00
F +48 22 335 26 01

Slovak Republic

DELTA ELECTRONICS (SLOVAKIA), s.r.o.
Botanicka 25/A, SK - 841 04 Bratislava,
Slovakia
T +421 (0)2 6541 1258
F +421 (0)2 6541 1283

Spain

Delta Energy Systems (Spain) S.L.
C/Luis I, n°60, Nave 1A, 28031 - Madrid, España
T +34 91 223 74 20
F +34 91 332 90 38

Switzerland

Delta Energy Systems (Switzerland) AG
Freiburgstrasse 251, 3018 Bern-Bümpliz,
Switzerland
T +41 31 998 53 11
F +41 31 998 54 85

Turkey

Delta Greentech Electronic San. Ltd.
Serifali Mevkii Barboros Bulvari Soylesi Sok No
19 Y.Dudullu-Umraniye/Istanbul, Turkey
T +90 216 499 9910
F +90 216 499 8070

United Kingdom

Delta Electronics Europe Ltd.
1 Redwood Court, Peel Park Campus, East
Kilbride, G74 5PF, United Kingdom
T +44 1355 588 888
F +44 1355 588 889

Middle-East & Africa

South Africa

Delta Energy Systems MEA (Switzerland) AG
South Africa Representative Office
Unit 305B, Lougardia Building, Cnr
Embankment and Hendrik Verwoerd Drive,
Centurion, 0157, South Africa
T +27 12 663 2714
F +27 86 667 0469

Americas

Argentina

Delta Greentech
Rio de Janeiro 58 piso 2 Buenos Aires CABA
T +54-911-317 605 11

Brazil

Delta Energy Systems (Brazil) S/A
Rua Itapeva, N° 26 - 3° andar
01332 000 - São Paulo - SP
T +55 11 3568 3850
F +55 11 3568 3865

Colombia

Delta Greentech
Hacienda Fontanar Nogal 144
Chia-Colombia
T +57 1 673 4927
F +57 1 673 4927

Asia Pacific

China

Delta GreenTech (China) Co., Ltd.
238 Minxia Road, Pudong, Shanghai,
201209 P.R.C
T +86 21 5863 5678
+86 21 5863 9595
F +86 21 5863 0003

India

Delta Power Solutions (India) Pvt. Ltd.
Plot No. 43, Sector-35, HSIIDC,
Gurgaon-122001, Haryana, India
T +91 124 4874 900
F +91 124 4874 945

Taiwan

Delta Electronics Inc.
39 Section 2, Huandong Road,
Shanhua Township
Tainan County 74144, Taiwan
T +886 6 505 6565
F +886 6 505 1919

Australia

Delta Energy Systems Australia Pty Ltd.
Unit 20-21, 45 Normanby Road, Notting
Hill VIC 3168, Australia
T +61 3 9543 3720
F +61 3 9544 0606

Thailand

Delta Electronics (Thailand) Public Co.,
Ltd.
909 Soi 9, Moo 4, E.P.Z., Bangpoo
Industrial Estate, Tambon Prakasa,
Amphur Muang-samutprakarn,
Samutprakarn Province 10280, Thailand
T +662 709-2800
F +662 709-2833

Singapore

Delta Electronics Int'l (Singapore) Pte Ltd.
4 Kaki Bukit Ave 1, #05-04, Singapore
417939
T +65 6747 5155
F +65 6744 9288